

Subject : *Implementation of the materials making up the Adam Matériaux facade and plaster system*

This version of the Adam Matériaux technical note dated 01/05/2025 replaces all previous versions *ETICS = composite systems for external thermal insulation with coating*, which includes the Adam Matériaux Etics facade and rendering system.

**Introduction:** Our Adam Matériaux Etics facade and rendering system is designed to insulate and render old and new facades and walls. By applying the Adam Matériaux Etics facade and rendering system to your facades and walls, you will beautify your facades, stop infiltration due to rain and significantly improve the energy certificate of insulated and rendered facades and walls.

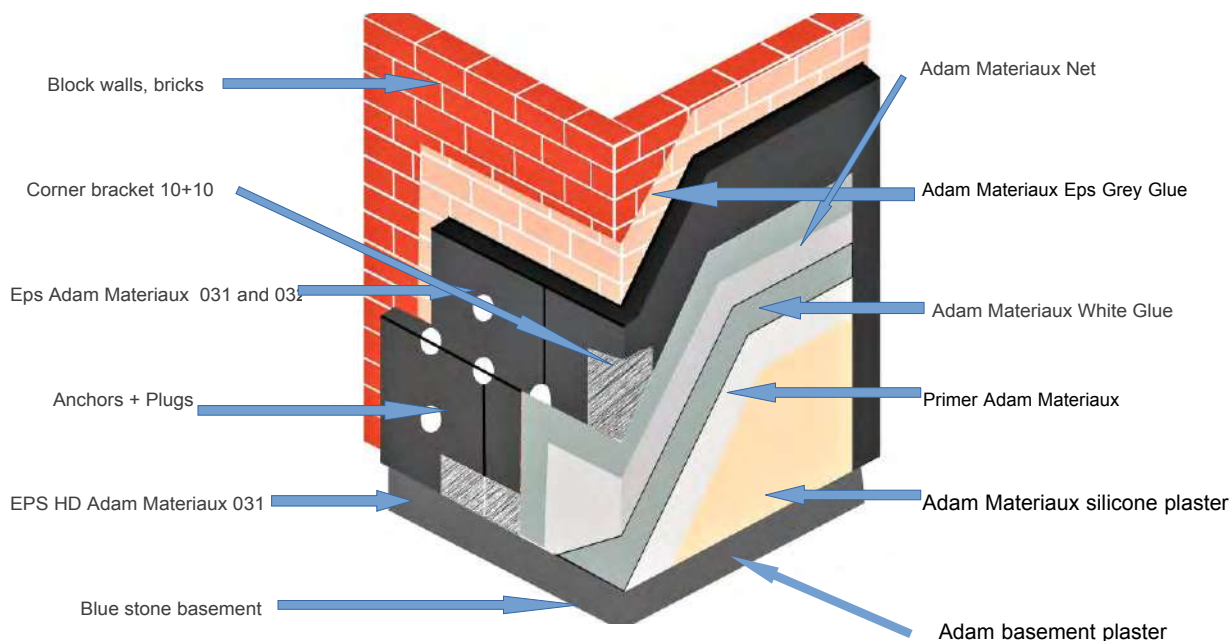

Starting angle complex in ALU LO-AL or starting angle complex in PVC LW206 / LW-L / LZ23

- . Fire reaction class = B-S1, do
- . Thickness of the Adam Matériaux High Density (HD) EPS insulation Facade = EPS with mortise and tenon edges from 20 to 300mm
- . Thickness of the Adam Matériaux EPS insulation of facades = EPS with straight edge from 20 to 300mm. Lambda value (Y) of the Adam Matériaux EPS insulation = EPS Graphite (grey) 0.032 and 0.031. Thickness of the Adam matériaux system glue + reinforcement net + coating = 4 to 5mm

- Indeed, after insulation (thickness of the insulation to be defined on a case-by-case basis with the project owner) and the installation of the plastering of his home, **the project owner will directly save on heating the insulated home** in cold weather and cooling (air conditioning) in hot weather. The greater the thickness of the insulation installed and the lower the lambda (Y) of the insulation installed, **the higher the energy gains of the insulated facades will be.**

## Technical note on the Adam Matériaux facade and plaster system

Therefore, choose the thickest possible insulation depending on the possibilities of the facade to be insulated, such as the position of windows and sills, gutters and downspouts, roof overhangs, facade adjoining walls, sidewalks, etc.

Regarding **the energy needs of each home**, no owner or tenant in Europe can now claim to ignore **the energy certificate** of the house they live in, rent in, or even wish to sell. Indeed, the energy certificate of each house, known **in Belgium as the PEB (Energy Performance of Buildings) and in France as the "Energy Performance Diagnosis,"** has become a real selling and rental argument and significantly influences the sale and rental price of each house across Europe. Therefore, Adam Matériaux' insulation and rendering work will enhance the appearance, stop rainwater infiltration, and, above all, **improve the energy certificate** of each house and thereby significantly **increase the sale or rental price of the insulated house.**

Additionally, facades insulated with the Adam Matériaux Etics facade and rendering system offer **increased comfort to the residents of the insulated house** by providing a more stable temperature and avoiding cold spots in the home, unlike facades not insulated with the Adam Matériaux Etics facade and rendering system. Numerous municipal, regional, and national incentives exist depending on the address in Europe where the house to be insulated with the Adam Matériaux Etics facade and rendering system is located.

**All information and details** on our various products in the Adam Matériaux Etics facade and rendering system, such as prices, stock levels, photos, videos, technical data sheets, etc., **are permanently** available on [adammatériaux.be](http://adammatériaux.be).

All information regarding **the installation of products** in the Adam Matériaux Etics facade and rendering system can also be obtained by consulting NIT 257, NIT 274, and NIT 279 from the technical and scientific center for construction "Buildwise" ([www.buildwise.be](http://www.buildwise.be)).

All products in the Adam Matériaux facade and rendering system have **the CE marking.**

NIT recap 17 summarizes the main points of facade and rendering work in 25 pages.



Guaranteeing EEC manufacturing quality and are also guaranteed by **the Belgian ATG 3119 certifications as well as by the French ACERMI 22/271/1571 certification**

## TABLE OF CONTENTS

1. General recommendations for the Etics facade and rendering system Adam Matériaux *pages 7 to 9*
  
2. ATG and ACERMI certifications for the Etics facade and rendering system Adam Matériaux *page 10*
  
3. Protections to place before starting your facade and plastering work *pages 11 and 12*
  
4. Departure of the facades of the Adam Matériaux facade and plaster system *pages 12 to 17*
  - 4.1. Departure from the facades with the starting complex in ALU LO-AL *page 13 and 14*
  
  - 4.2. Departure of the facades with the PVC starting complex *pages 15 to 17*
  
5. Cutters for cutting EPS insulation Adam Matériaux *page 18*
  
6. Installation of the insulated base with Adam Matériaux EPS HD insulation *pages 19 to 23*
  
7. Collage of the Adam Matériaux HD EPS *pages 24 to 27*
  
8. Installation of the Adam Matériaux HD EPS fixing dowels *pages 27 to 32*
  - 8.1. Length of dowels to choose for doweling the Adam Matériaux HD EPS *page 28*
  
  - 8.2. Anchors to be used for new facade and old undamaged facade *page 29*
  
  - 8.3. Anchors to be used for terracotta block facades and damaged old facades *page 29*
  
  - 8.4. Doweling system to be used for doweling Adam Matériaux HD EPS on wooden facades *pages 30 and 31*
  
  - 8.5. Using the orange strawberry + EPS caps to close the ankles *pages 31 and 32*

9. Coating of Adam Materiaux HD EPS and installation of Adam Materials reinforcement mesh  
*pages 33 and 34*

10. Installation of the LS-VH stop angle with reinforcement net to be placed against the frames  
before starting the work of installing the Adam Matériaux EPS insulation *pages 34 to 37*

11. Installation of the pre-compressed sealing strip (compriband) TP600 on the fixed frames of the  
frames next to the LS-VH 06 angles *pages 37 and 38*

12. Installation of the Adam Matériaux 032 or 031 EPS which begins either on a starting angle complex in  
ALU LO-AL or a starting complex in PVC (as for the start of the HD EPS) *pages 40 and 41*

13. Data, thicknesses, packaging and dimensions of EPS Adam Materiaux 031 and 032 *pages 41 and 42*

14. Bonding of EPS Adam Facade Materialux *pages 43 to 46*

15. Respect for the verticality of the Adam Matériaux EPS even if the facades are not straight *pages 47 and 48*

16. Connection of the Etics system of Adam Matériaux facades and plasters to the side edge (gable wall)  
of a sloping roof and to the upper facade profiles *pages 49 and 50*

17. Fire barrier during installation of the Adam Matériaux facade EPS *page 50*

18. Installation of aluminum or blue stone window sill on EPS Adam Matériaux *pages 51 to 54*

19. Installation of LA-R corner tissues in the corners of windows and doors on the Adam Matériaux facade EPS  
*pages 55 and 56*

20. Adam Matériaux facade EPS anchoring *pages 56 to 58*

21. Installation of the various angles and blocks provided in the Etics facade system and Adam  
Matériaux rendering *pages 58 to 70*

21.1.1 Installation of the corner bracket for windows, doors and facade corners LK PVC Premium 2.5  
meters with 10x10cm reinforcement net on the EPS Adam Matériaux *pages 58 to 60*

21.1.2 Installation of the corner bracket for windows, doors and facade corners LK-VH PVC 2.5 meters with reinforcement nets and guide for laying glue and plaster without overflows *page 61*

21.2. Installation of the "Balcony" LTD 2.5 meter angle with water drop with 10x10cm reinforcement net on the EPS Adam Matériaux *pages 61 and 62*

21.3. Installation of the 2 meter LCL stop angle with 10cm reinforcement net on the Adam Matériaux EPS *pages 62 to 64*

21.4. *Installation of LD-LS 90° or 180° PVC expansion angle on Adam Matériaux EPS pages 64 and 65*

21.5. Installation of blocks before coating the EPS Adam panels Facade materials for the installation of lighting, alarms, taps, downspouts, shutters, railings, sun tents, ramps. *pages 65 to 70*

21.5.1 Spirals for very light loads *page 66*

21.5.2 Variq or Varir blocks for light and semi-heavy loads. *pages 66 and 67*

21.5.3 UMP blocks for heavy loads *pages 67 and 68*

21.5.4 TRA-WIK - PU heavy duty corner blocks *pages 68 and 69*

21.6. Installation of block for electrical outlet before coating of EPS panels Adam Facade materiaux *pages 69 and 70*

22. Coating of EPS Adam Facade *Materiaux pages 70 to 78*

22.1. Checks to be carried out before coating the Adam Materiaux EPS *pages 70 to 75*

22.2. Coating of Adam Matériaux EPS facade with Adam Matériaux grey and white glue *pages 75 to 78*

- 22.3. Checking the flatness and drying of Adam Materiaux gray or white glue *pages 78 to 79*
23. Application of Adam Matériaux Primer, Plaster and Silicone Paint *pages 79 to 84*
- 23.1. Application of the Adam Materiaux Primer *pages 80 and 81*
- 23.2. Application of Adam Matériaux silicone plaster *pages 82 and 83*
- 23.3. Application of Adam Materiaux silicone paint *page 84*
24. Map of the 274 colors of Adam Matériaux primers, plasters and silicone paints *pages 85 and 86*
25. Installation of the base in blue stone or with a structured Adam Matériaux base plaster at the bottom of the facades *pages 86 to 89*
- 25.1. Installation of the blue stone facade base *page 87*
- 25.2. Laying the base with Adam "M" plaster Materiaux for baset *pages 88 and 89*
26. Map of the 56 colors of Adam Matériaux structured basement plaster *pages 89 and 90*
27. End of facade and plastering work Adam Matériaux *pages 90 and 91*
28. Improvements to the surroundings of isolated facades *pages 91 and 92*
29. Adam Materiaux Traceability of the products implemented *pages 92 and 93*
30. Maintenance and pathologies of the Etics system of Adam Matériaux facades and plaster *pages 94 to 96*
- 30.1 Cleaner and algae treatment for Adam Matériaux plastered facades (Fungicide) *pages 95 and 96*
31. Finished appearance and tolerances of Adam Matériaux facade and plastering work *page 96*

## **1. General recommendations for the Adam Matériaux facade and plaster system (ETICS)**

- The Adam Matériaux Etics facade and plaster system is suitable for facades to be covered with Adam Matériaux **EPS insulation** on which Adam Matériaux **plaster** must be applied.
- The Adam Matériaux Etics facade and plaster system is suitable for **new construction and renovation**.
- The Adam Matériaux Etics facade and rendering system begins **at least 30cm above the exterior ground level**. It is **therefore mandatory** to start the insulation of the facades with **Adam Matériaux EPS HD (High Density) at a minimum height of 30cm**.
- It is mandatory **not to "mix" the Adam Matériaux Etics facade and plaster system with other brands of insulating facade systems** for warranty reasons. Indeed, by mixing facade insulation systems, the client and **the project owner automatically lose all manufacturer warranties**.
- The ambient temperature **during all Adam Materiaux system installation work** must be **between 5°C and 30°C day and night**. Do not work outside these temperatures.
- It is recommended **to define before the work**, with the project owner, **all the technical details of the facade work** such as the thickness and choice of insulation, the desired thermal requirements, the thickness of the EPS HD Adam Basement Materials insulation, the finishes, the connections, the grain size and color of the rendering, the various roof connections and gutter overhangs, the connections with the other facades, the replacement of frames before work, the electrical work to be carried out on the facades to be insulated such as the installation of lighting and cameras and alarms, the installation of external taps, ....
- It is recommended **to check the stability of the old facades** to be insulated before the Adam Matériaux facade and rendering work, possibly with an engineer's study, as well as to ensure that the management of water vapor and air tightness have been taken into account by the project owner via, for example, **a specialized design office**, and this in all cases when it comes to wooden structures (timber-framed house, wooden chalet, support panels, etc.)

## Technical note on the Adam Matériaux facade and plaster system

- When installing the Adam Matériaux Etics facade and plaster system on a wooden structure, **the humidity level must be a maximum of 18%**.
- **In the event of out-of-plumb facades** before the Adam Matériaux facade and rendering work, it is recommended to carry out **a very precise inventory** with the project owner. If necessary, **take corrective measures before the start of the Adam Matériaux facade and rendering work**, possibly by applying a leveling layer with another type of insulation and/or suitable cementing. In any case, **the flatness of the facades must comply** with the NBN EN 13670 and NBN 15-400 standards.
- The Adam Matériaux Etics facade and rendering system cannot be installed **on a facade with cracks or unstable shapes**, nor on a wall exceeding the permissible deviation tolerances, namely 15mm/2 meters, see NIT 257 from Buildwise on pages 45 to 50.
- **On old facades**, it is recommended to clean the exterior facades **with water pressure** before Adam Matériaux facade and plastering work.
- If there are cement, plaster, lime or paint slabs on the facades, **they must be removed mechanically** before work begins.
- When paint is present on the facades, it is mandatory **to sand or sand the facades** on at least 60% of the surface, and then carry out a water pressure cleaning of the facades. **No primer replaces sanding or sanding of the facades.**
- **It is mandatory to anchor Adam Matériaux EPS insulation panels to existing facades.**
- **In the event of rising damp**, contact damp, moss, algae, or efflorescence on the facades, the causes must be addressed by a professional and the problems must be allowed to dry or disappear completely **before installing Adam Matériaux EPS insulation panels.**
- Interior plastering and screed work must be completed and completely dry **before beginning the Adam Matériaux facade and rendering** work. This plastering and screed work **must be carried out at least 4 months** before the insulation work on your facades.
- It is recommended that you remove **blinds, shutters, sunshades, electrical cables, outdoor faucets**, etc., before the Adam Matériaux facade and rendering work, and plan to install new ones after the Adam Matériaux facade and rendering work. Leaving old blinds, shutters, and sunshades **in place with insulation around them is unsightly and causes numerous thermal bridges.** After gluing the Adam Matériaux EPS panels, you should plan to install **VARIQ and UMP blocks** to secure the new blinds, shutters, sunshades, lamps, faucets, etc. after the Adam Matériaux facade and rendering work
- It is recommended to protect the materials from rain, frost, and sun throughout the entire duration of the Adam Matériaux facade and rendering work.



### **Illmod TP600 pre-compressed sealing strip (compriband)**



- Ensures the waterproofing of the Etics Adam Matériaux facade and plaster system **with the connections of other matériaux not belonging to the Etics Adam Matériaux system.**
- Is a **pre-compressed waterproofing strip** resistant to driving rain **up to 600 Pa** and which must be used **to seal the connections** of the Etics Adam Matériaux system **with other parts of the building (such as windows, doors, thresholds, roofs, blocks, ...)**
- The Illmod TP600 compression seal is used to ensure the sealing of the Etics Adam Matériaux system **with connections to other materials.**
- Available with a width of 25mm and a useful thickness between 10 and 22mm.

**- It is mandatory to place an illmod TP600 compriband**

Between the Adam Matériaux EPS HD insulation and the **aluminum or PVC starting material.**

- Between the Adam EPS HD insulation and the **aluminum or PVC starting material for flat roofs, sloped roofs, and balcony and terrace connections.**
- Between the Adam Matériaux EPS and the facade around the frames before **the LS-VH06 angle on the insulating side**
- Below the sill or by installing **the LX-LPE corner bead.**
- On the sides of the window sill or by installing the **LX-SPP corner bead.**
- Around **VARIQ, VARIR, UMP, etc. blocks**
- Between the Adam Matériaux EPS insulation and **the upper part of the facades, such as wood, concrete, PVC, etc.**
- Around any element not part of the Etics Adam Matériaux system.
- Between the Adam Matériaux EPS insulation and **parts of the building that do not require insulation.**
- Between the Adam Matériaux EPS insulation and **the roof and wall cladding edges.**
- Between the Adam Matériaux EPS insulation and **openings and fasteners.**

## **2. ATG and ACERMI certifications regarding the system**

### **Adam Matériaux facade and plastering etics**

#### **-ATG 3119 Adam Matériaux concerns the following products installed on brick, concrete block and terracotta block facades**

- EPS Adam Matériaux 0.031 and EPS Adam Matériaux 0.032
  - PVC corner brackets LW206, LW-L and LZ23
  - LK PVC corner bracket + LK-VH corner bracket with guide
  - LK-KL bendable corner bracket
  - LTD Water Drop Corner
  - LX-LPE Window Sill Corner
  - LX-SPP Window Sill Corner
  
  - Plaster stop angle LS-VH 06
  - Plaster stop angle LC-L
  - LA-R Corner Tissue
  - LD-LS 180° Expansion Angle
  - LD-LS 90° Expansion Angle
  - Adam Matériaux Grey Adhesive for Bonding + EPS
- Coating
- Koelner KI-10 Anchors
  - Wkret-Met LMX-10 Anchors
  - Wkret-Met Eco-Drive Anchors
  - Illbruck Illmo d 600 Reinforcing Strip
  - Adam Matériaux 145g Facade Reinforcing Net
  - Adam Matériaux Exterior Primer for Rendering
  - Adam Matériaux Silicone-Acrylic Render

#### **Recommandations:**

- Adam Matériaux ATG 3119 does not cover work **on wood or metal facades.**
- To benefit from the Adam Matériaux ATG 3119 warranty, **it is prohibited to mix** Adam Matériaux facade and rendering products **with products from other brands.**
- To benefit from the Adam Matériaux ATG 3119 warranty, it is mandatory to comply with Adam Matériaux ATG 3119 and this Adam Matériaux technical note.

#### **-The French ACERMI 22/271/1571 Certification concerns the EPS 031 Adam Matériaux insulation**

### **3. Protections to place before starting your facade work**

**Protect floors, windows, doors, thresholds, etc. before your work**

. **Protective plastic** to put on floors, low walls, etc. (visqueen):



. **Blue self-adhesive plastic** for chassis protection:



. **.48mm orange tape** for chassis protection:



. Fix your scaffolding with **pitons**:



Protect your facades to be insulated and rendered from bad weather with **PE tarpaulins or protective nets**: The installation of PE tarpaulins and protective nets provides effective protection against wind, rain, cold, sun and heat, etc. and reduces the risk of "rework" in the rendering installation and thus guarantees quality facade and rendering work for your customers.

**PE tarpaulins:**



**Safety nets:**



All these protective measures before Adam Matériaux facade and rendering work guarantee you maximum positive feedback from your customers..

#### 4. Departure of the facades of the Adam Matériaux facade and plaster system

**It is mandatory** to place a starting angle **at least 5mm from the ground** in the Etics facade and Adam Matériaux rendering system regardless of the floor covering, as well as at the start of the Etics facade and Adam Matériaux rendering system on flat roofs. Leave a minimum of 5mm from the ground **to prevent rainwater** from wetting the bottom of the Etics facade and Adam Matériaux rendering system.

There are 2 possibilities: **starting angle complex in ALU LO-AL or starting angle complex in PVC**

The joints between each starting angle must be offset by at least 20cm from the joints between the Adam Matériaux HD EPS panels.

**4.1. Departure of the facades with the complex with starting angle in  
ALU LO-AL**

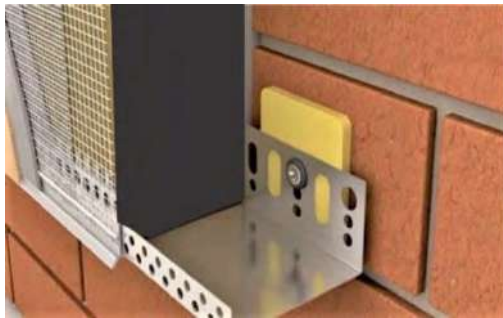

Adam Matériaux HD EPS Insulation



LE-G bib

**This is made up of:** the **ALU LO-AL** starting angle to be fixed in the existing facade in blocks, bricks, etc. and the **LE-G apron** to be clipped onto the **Alu LO-AL** starting angle: The water droplet ensuring perfect evacuation of the **LE-G apron** angle eliminates the appearance of humidity by capillarity under the insulation.



Corner ET (Flap)



Installation of the LE-G Flap angle

The **30mm connectors** to be placed between each starting angle in **ALU LO-AL**:



The connectors between the starting angles allow for thermal expansion.



**PVC adjustment** shims in 2, 3, 4, 5, 8, 10 and 15 mm to adjust the **ALU LO-AL** starting angles against the facade:



**Koelner FX 6x40mm or 6x60mm** hammer-in anchors for fixing **LO-AL** starting angles in the facade

Diagram of the starting **angle complex in ALU LO-AL**:

Adam Matériaux HD EPS Insulation



#### 4.2. Departure of facades with the complex with PVC starting angle

- It is recommended to use **the PVC starting complex LW-L+ LZ23 + LW206** to avoid thermal bridges **unlike** the starting ALU angles LO-AL.
- The 3 **PVC angles LW-L+ LZ23 + LW206** are adjustable between them to obtain the desired width depending on the thickness of the desired Adam Matériaux HD EPS.
- The water droplet ensuring perfect drainage of the **LW206** angle eliminates the appearance of humidity by capillarity under the insulation.
- -The 3 PVC corners **LW-L+ LZ23 + LW206** protect the Adam Matériaux facade system against bad weather and micro-cracks in the long term.

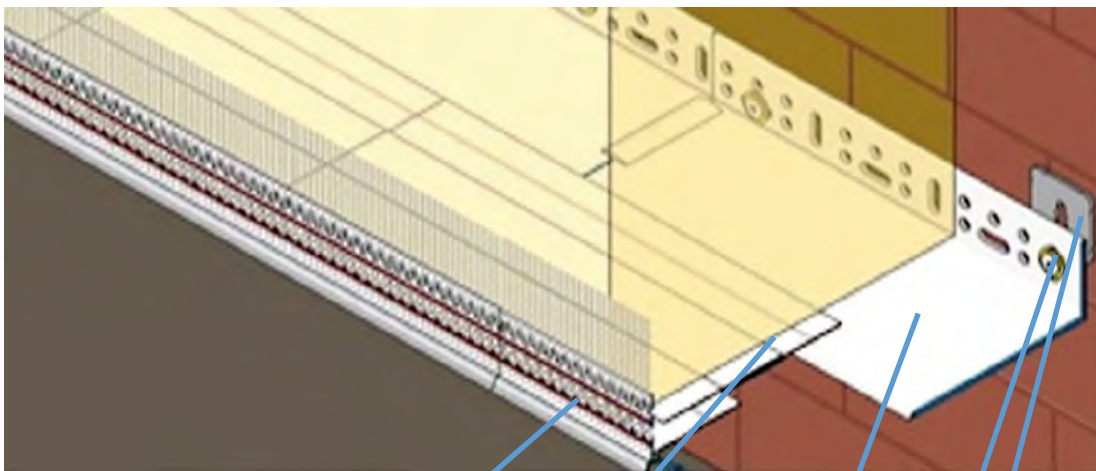

PVC starting angle LW206 200 x 8,6 x 10cm

PVC connector LZ23 to connect the angle iron LW206 and LW-L

PVC LW-L starting angle available in widths of 5, 10 and 16 cm

Koelner FX hammer anchor

PVC adjustment wedge

Diagram of the PVC starting angle complex



Adam Matériaux EPS HD insulation + LW-206 angle + LZ 23 angle + LW-L angle

To begin, you must choose the width of the **LW-L angle iron**, either 5, 10 or 16cm depending on **the thickness** of the EPS insulation to be fixed in the existing block or brick facade. Dimensions of the angle iron = Length: 200cm Width of foot: 5, 10 or 16cm and Height of return against wall: 4cm



The **LW-L corner** is secured to the wall with **Koelner FX wall plugs**. The **30mm connectors** must be placed between each starting corner of the **LW-L+ LZ23 + LW206 PVC complex**.



30mm adjustment connectors



Koelner FX ankle

You must also use the **PVC adjustment shims** in 2, 3, 4, 5, 8, 10 and 15mm to adjust the **LW-L starting angles against the facade**.





Adjustment shims



LW206 Corner

Next, install the **LW206** PVC starter angle.

The **LW206 angle** has a **return with reinforcing mesh on the front** of the Adam Materiaux EPS insulation.

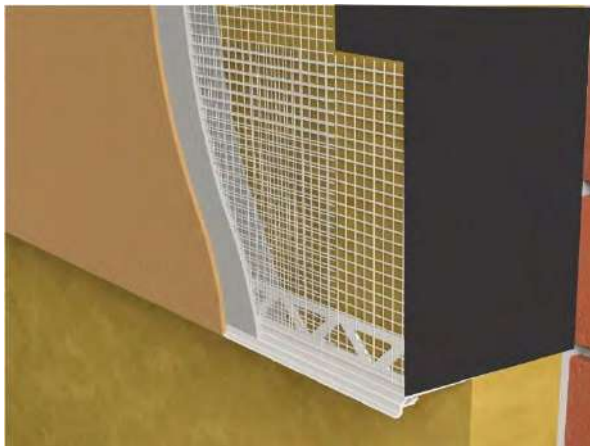

Adam Materiaux HD EPS Insulation



LW-206 angle dimensions = Length: 200cm Foot width: 8.6cm and **Return height with reinforcement mesh: 10cm**

The **LZ23 angle iron** is used to connect the angle iron on the facade, either the LW-L angle iron with the angle iron going up on the EPS insulation or the LW-206 angle iron.



LZ23 angle iron



Adam Materiaux HD EPS Insulation  
LW-206 Corner + LZ23 Corner + LW-L Corner

## **5. Cutters for cutting EPS insulation Adam Materiaux**

It is very **important** to provide **quality work to your customers** to have **electric cutters** to have clean cuts in your insulation and avoid putting waste (balls) everywhere in the environment and at the neighbors of your work.

### **Handschneider 20 hand cutter:**



### **Termo-cut 1101 footless cutter:**



### **Max GJ cutting machine with feet:**



### **Use spare wires**

for **Termo-cut 1101** and **Max GJ** cutters:



## **6. INSTALLATION OF THE INSULATED SUB-BASE WITH EPS HD INSULATION Adam Materiaux**

**Adam Matériaux High Density (HD) EPS insulation must be placed at the start of the facade and flat roof of the Adam Matériaux Etics facade and rendering system, with a minimum of 2 cm of clearance from the EPS facade insulation and to a minimum height of 30 cm:**



Adam Matériaux HD EPS Insulation

### **6.1. Installation of Adam Materiaux HD insulation Basement**

-Whether **in new construction or renovation**, the start of the Adam Matériaux Etics facade and rendering system (ETICS) must be carried out with **Adam Matériaux High Density (HD) EPS insulation**.

- The Adam Matériaux Etics facade and rendering system begins **at least 30 cm above the exterior ground level**. It is therefore **mandatory to start** facade insulation with **Adam Matériaux HD (High Density) EPS at a minimum height of 30 cm**.

This height can be reduced to 15 cm for facades that are not exposed to impacts or water splashes (starting on a flat roof, for example) – page 8 of NIT recap 10

-The **connections** must be designed and made according to the details of **the PVC starting complex or the Aluminum complex** see pages 12 to 17 and in such a way as to ensure the continuity of the insulation layers, so that water cannot infiltrate or stagnate at the junction, and that the visible face of the Adam Matériaux plaster is set **back by at least 2cm** from the insulated plinth (basement). This setback will allow rainwater running down the facade to be diverted and facilitate the junction using the **PVC starting angle complex or the Aluminum complex** and the compressed sealing strip.

-It **is therefore also mandatory to install Adam Matériaux High Density (HD) EPS insulation** under the Adam Matériaux facade and plaster system and **at the start of the flat roof.**



Adam Matériaux EPS HO Insulation

**-It is also mandatory to install Adam Matériaux High Density (HD) EPS insulation** at the **start of sloping roofs** of the Adam Matériaux facade and plaster system.



A. View before laying the roof covering

B. View after laying the roof.

Connection of the ETICS Adam Matériaux at the start of a sloping roof



1. Roof underlayment survey
2. Roof thermal insulation
3. Adam Matériaux HD EPS starter insulation
4. Recessed gutter
5. Flashing
6. PVC LW 206 starter profile
7. Illmod TP600 compribande joint
8. Adam Matériaux EPS insulation

Source: Pages 67 and 68 of Buildwise NIT 257

- It is **mandatory** to install the **Adam Matériaux High Density (HD) EPS** base with **a minimum of 2cm** of clearance from the Adam Matériaux EPS facade insulation when installing the Adam Matériaux Etics facade and plaster system.

- Adam Matériaux 0.031 EPS HD **with tenon and mortise** is available in thicknesses from **2 to 30cm**.

- **Suitable waterproofing** must be provided at the base of the wall.

- Adam Matériaux EPS HD insulation must be installed:

- At a **minimum height of 30 cm above ground level**.

**The ground level** of a home for work using the Adam Matériaux Etics facade and rendering system corresponds to **the ground level of the natural terrain**.

Above the wall's capillary barrier.

During renovation, potential problems, such as humidification of the wall by rising damp, walls against the ground, etc., must be resolved prior to the installation of the Etics facade system and Adam Matériaux rendering.

Example : If the Adam Matériaux EPS facade insulation has **a thickness of 14cm**, Adam Matériaux EPS HD insulation with **a minimum thickness of 12cm must be placed if Adam Matériaux basement plaster is placed in the basement**.

**If a blue stone is placed as a base** for the Adam Matériaux facade and rendering system, the thickness of the stone must be **deducted in addition to the minimum 2cm of mandatory setback**.

And so, if the Adam Matériaux EPS facade insulation has **a thickness of 14cm**, it is necessary to place an Adam Matériaux EPS HD insulation with **a minimum thickness of 10cm** if a stone with a thickness of 2cm is placed in the basement, to maintain the **minimum 2cm** of mandatory withdrawal from the facade insulation.

**Adam Matériaux High Density (HD) EPS**



Source: Pages 49, 50, 51, 52, and 53 of Buildwise NIT 257

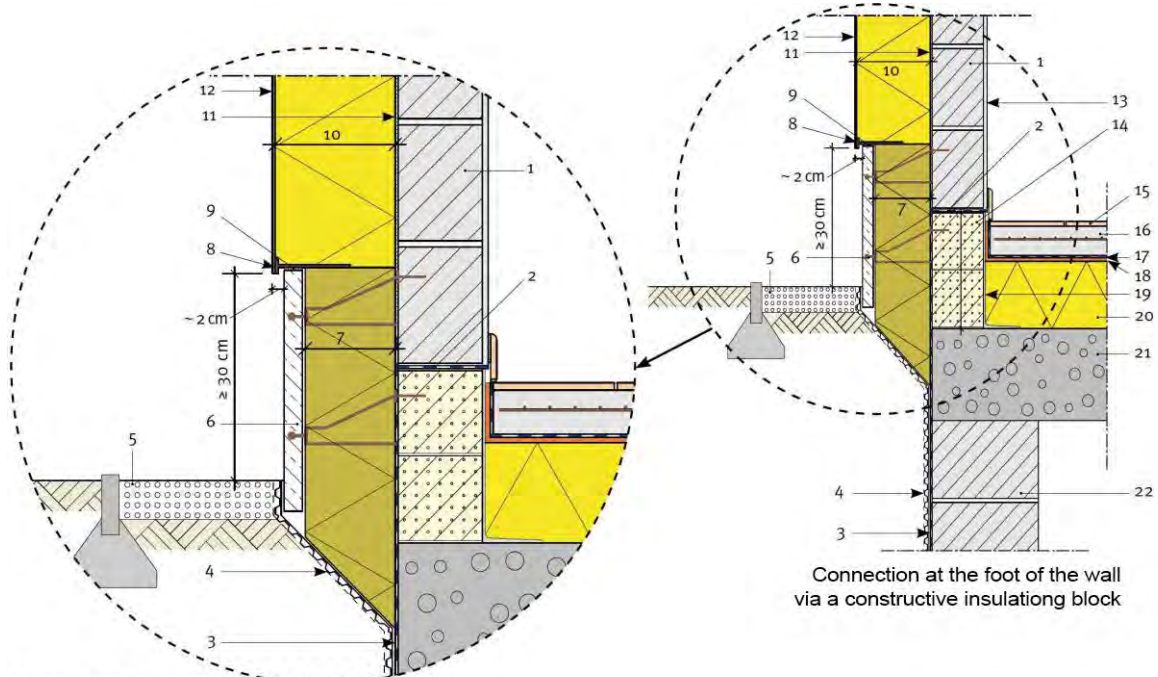

Connection at the foot of the wall  
 via a constructive insulating block

Connection between the ETICS  
 insulation and the base insulation

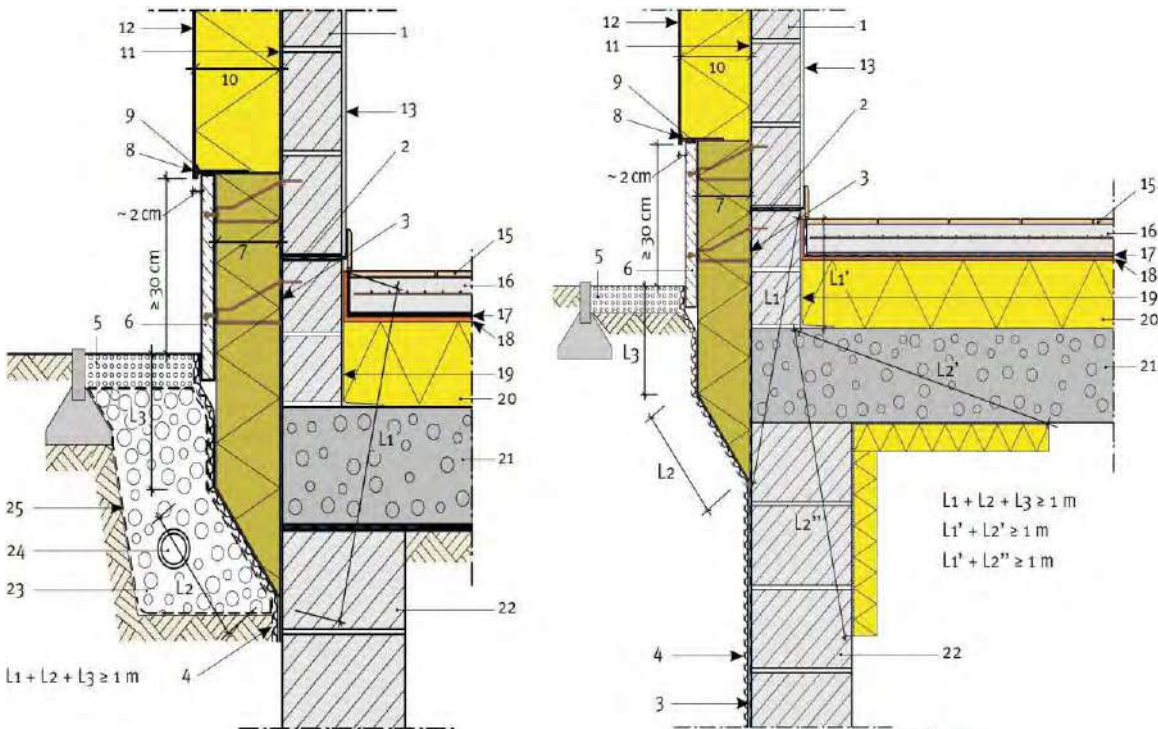

A. on solid ground

Connexion in a protected non-buried volume made without interposed insulating elements

B. on adjacent unheated volume  
 (cellar, crawl space,...)

$$L1 + L2 + L3 \geq 1 \text{ m}$$

$$L1' + L2' \geq 1 \text{ m}$$

$$L1' + L2'' \geq 1 \text{ m}$$

1. Load-bearing masonry, bricks, blocks
2. Capillary barrier
3. Waterproofing (roofing, EPDM membrane, etc.)
4. Extrusion membrane for buried walls to be installed before work
5. Gravel (drainage) after work
6. Bluestone plinth or Adam Matériaux basement render
7. Moisture-resistant basement insulation such as Adam Matériaux EPS HD
8. PVC or aluminum basement compound
9. Compressed waterproofing strip such as Illbruck Illmod 600 compriband
10. Adam Matériaux EPS insulation panel
11. Adam Matériaux gray or white adhesive
12. Adam Matériaux primer + render
13. Interior plaster
14. Insulating building block
15. Interior floor finish
16. Interior screed
17. Interior membrane (if applicable)
18. Interior acoustic insulation
19. Airtightness (if applicable)
20. Thermal insulation of the floor
21. Load-bearing slab (e.g., poured reinforced concrete)
22. Buried masonry
23. Drainage materials (gravel)
24. Collector (drain with coconut fiber and/or geotextile)
25. Filter (gravel)

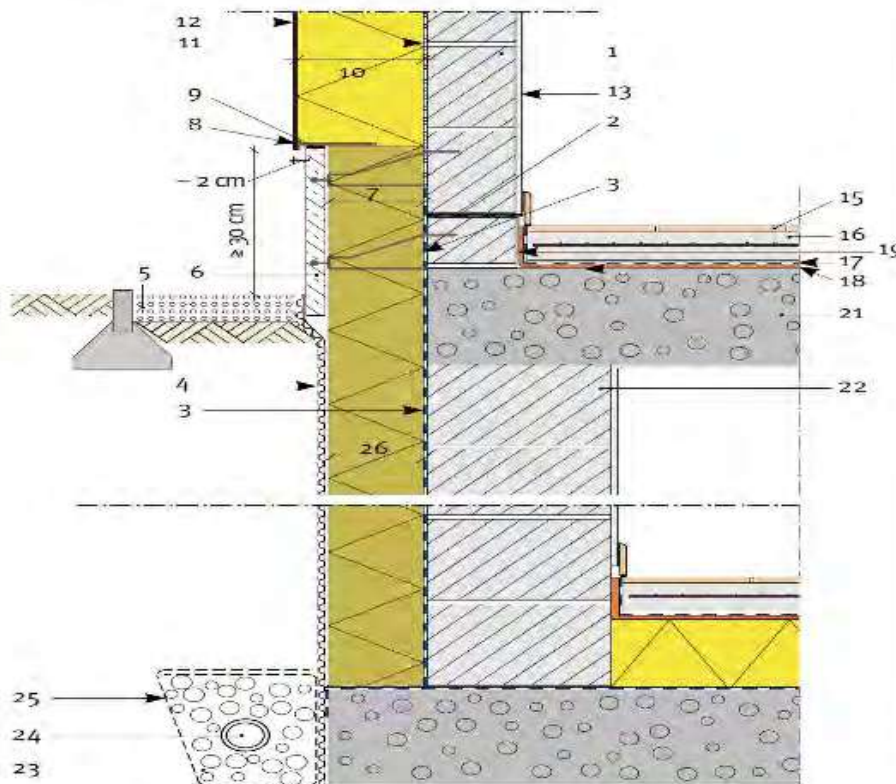

Connections in a partially buried protected volume

## 7. Collage of the Adam Matériaux HD EPS

Use Adam Matériaux Grey Glue or White Glue for bonding to brick and block walls

Consumption = 4-5 kg/m<sup>2</sup>.

**Mix** the Adam Matériaux grey glue well with an electric mixer with **a suitable propeller such as the Kubala M14** and add **between 5 and 5.5 litres of water** to a PVC bowl, **mixing for 3 to 5 minutes** at low speed **until the glue has a homogeneous consistency**.

Wait about 2-3 minutes and mix again. The homogeneity of the glue can be adjusted by adding water, but in an amount that does not exceed the upper limit (depending on weather conditions). Prepare portions of glue **to be used within the next 2 hours**. Mix the thickened glue **without adding water**.

Kubala M14 propeller



**Adam Matériaux Grey Glue is a homogeneous mixture and ready to use.**

### Different methods of bonding Adam Materials HD EPS are possible:

source: Pages 84, 89 and 94 of Buildwise's NIT

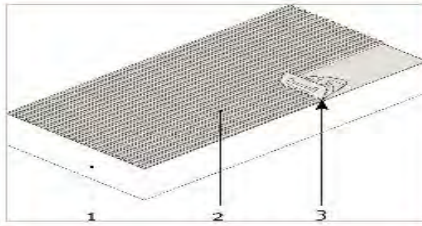
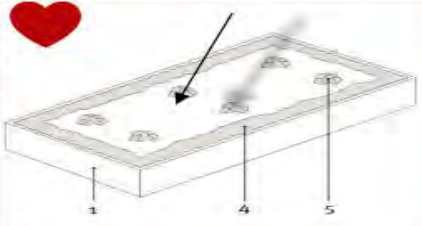
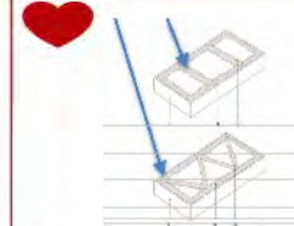
TECHNICAL	Full bonding for flat facades	PARTIAL BONDING	
		Gluing by pads	Gluing with peripheral strips
DESCRIPTION	Adam Matériaux glue is applied to the entire surface of the Adam Matériaux EPS insulating panel using a suitable 6x6mm serrated plasterboard.  <b>This method can be used on an absolutely straight facade</b>	Adam Matériaux grey glue is applied in the form of a continuous strip around the edge of the Adam Materials EPS insulation panel and in a number of spots distributed over the surface of the panel	Adam Matériaux glue is applied in the form of continuous strips around the edge of the EPS insulation panel and in strips distributed over the interior surface (two strips each applied at a third of the length of the insulation panel or in a W shape, for example)
	<b>IMPORTANT :</b> Contact surface after bonding minimum 40%		
ILLUSTRATION			
	<ol style="list-style-type: none"> <li>Adam Matériaux EPS HD, EPS 0032, or 0032 insulation panel</li> <li>Adam Matériaux gray or white glue or with Adam Matériaux PUR foam</li> <li>Use a 6x6 mm serrated plasterboard</li> <li>Adam Matériaux adhesive strip around the perimeter, approximately 50 mm wide</li> <li>Adam Matériaux adhesive pads, approximately 100 mm in diameter</li> </ol>		



Adam Materiaux Grey Glue



Adam Materiaux White Glue



Adam Materiaux PUR Foam



The **two most commonly used bonding methods** for bonding Adam Matériaux HD EPS panels are **the stud and peripheral strip methods** for the majority of facades.

Bonding can be used over the entire surface of the Adam Matériaux EPS panel for flat facades.



**Bonding** of Adam Materiaux EPS **by pads**, **the most widely used method**

**Recommandations** *for bonding Adam Matériaux EPS HD when installing the Adam Matériaux Etics facade and plaster system*

- Use Adam Materiaux **grey or white glue or PUR foam for bonding Adam Materiaux HD EPS panels** to brick and block walls.
- Adam Materiaux EPS panels must be glued **over at least 40% of the surface**, **in strips or pads with a continuous strip** of Adam Materiaux gray or white glue around the perimeter of the panels. Full gluing **with a serrated plasterboard, i.e. Kubala 0202 6x6mm, is also possible.**
- The Adam Matériaux grey or white glue must contribute to the sufficient flatness of the support and limit the deformations of the Adam Matériaux Etics facade and plaster system and prevent the circulation of air behind the Adam Matériaux EPS HD insulation panels.

- The vertical joints between the Adam Matériaux HD EPS panels must be alternated.
- Harping is mandatory in the corners
- The support must be **clean and healthy**
- It is **mandatory** to respect the water dosage for mixing the Adam Matériaux grey or white glue, **i.e. between 5 and 5.5 litres of water**, mixing **for 3 to 5 minutes**, as well **as the duration of its use, i.e. 2 hours.**
- After applying the Adam Matériaux grey or white glue to the EPS, **press the Adam Matériaux HD EPS directly** onto the vertical facade

After laying the EPS HD Adam Matériaux (minimum 24 hours in summer, **or even a few days in cold and humid weather** and before coating with the reinforcing mesh), it is **mandatory to sand the EPS HD Adam Matériaux insulation with a Kubala 0343 and 0344 rasp**, to obtain the best possible flatness of the EPS HD Adam Matériaux panels.



**Kubala rasp 0343 and 0344** for sanding EPS HD insulation Adam Matériaux

**The joints between each Adam Materialux EPS panel must be closed** with Adam Matériaux PUR foam:

Filling joints between Adam Matériaux HD EPS panels with Adam Matériaux PUR foam

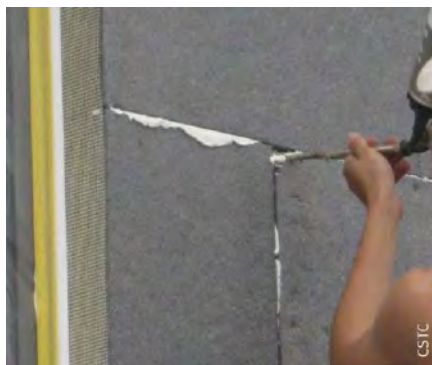

(NB : **It is forbidden to close joints between EPS panels** with gray or white glue Adam Matériaux)

This step is **very important to ensure minimal energy loss** from the home and to obtain an **optimal energy certificate (PEB)** for the client when installing the Adam Matériaux Etics facade and plaster system. **Use Adam Matériaux PUR foam** for bonding Adam Matériaux EPS HD to wooden facades and smooth concrete facades. **Utiliser la mousse PUR Adam Matériaux**

for bonding Adam Matériaux EPS HD to wooden facades and smooth concrete facades.

Apply **10 to 20mm strips of Adam Matériaux foam** for bonding Adam Matériaux HD EPS to wooden facades and smooth concrete facades.

EPS HD Adam materiaux



ADAM Matériaux EPS HD collage with Adam Matériaux **PUR foam on wooden facade**

## **8. Installation of the Adam Matériaux EPS HD fixing anchors with a minimum of 6 anchors per square meter**

**Attention :**

**Before you can anchor the Adam Matériaux HD EPS, you must wait for the Adam Matériaux grey or white glue to dry, which can take at least 48 hours and up to 10 days depending on weather conditions, seasons, temperatures and wind.**

If the doweling is carried out **before** the gray or white Adam Matériaux glue is dry, the glue will lose its hold and the EPS HD will only hold with the dowels, which could **cause cracks in the short or medium term.**

Diagrams showing the dowels with different EPS panels on their ends:

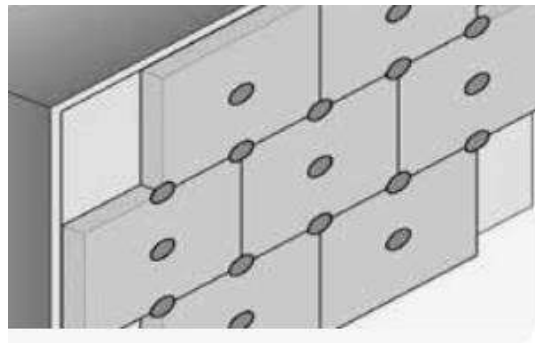
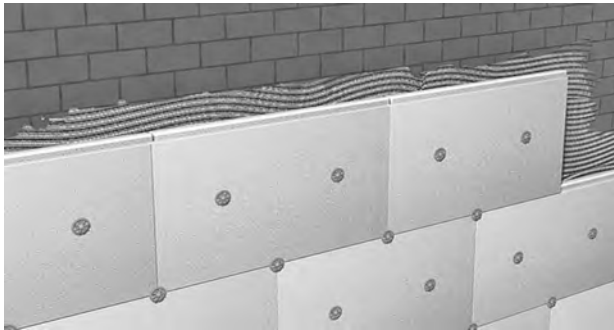

-It is recommended to work for the installation of the Etics facade and Adam Matériaux plaster system with **the 65mm orange cutter + 65mm EPS plugs** to place the dowels in the heart of the Adam Matériaux EPS HD insulation **to avoid the phenomenon of "ghosting"** the dowels when the plaster is observed **under a low sun** at 3 meters after the end of the work or **during cold weather in winter-**

In fact, **during frost** and if the plugs have not been placed on the dowels, the dowels **will be "visible"** through the plaster and will form as many points as dowels, which **will not be aesthetic.**

### **8.1. Length of dowels to choose for doweling the Adam Materiaux HD EPS**

To know the dowels to place in the Adam Matériaux HD insulation, you must allow **a minimum of 4cm** in addition to the thickness of the insulation.

Example : If the Adam Matériaux EPS HD is installed at **a thickness of 14cm**, you must place anchors of **at least 18cm**. If it is an **old facade or terracotta blocks**, a minimum of **6cm in addition to the thickness** of the insulation is recommended.

In any case, **the depth of the anchor** in the facade **must be at least 35mm**.

#### **Recommendations:**

-The number of dowels required when installing the Adam Matériaux Etics facade and rendering system is calculated according to the NBN EN 1991-1-4 standard, i.e. a minimum of **6 dowels/m<sup>2</sup>** is generally recommended for new and old homes.

**However, it is mandatory to anchor the Adam Materiaux HD EPS for:**

- **New facades** with a **height greater than 25 meters and 18 meters** in coastal regions
- **New or old facades that are out of plumb**
- **Old facades regardless of their height**
- **Wooden or metal facades**
- When subsequently covered **with brick or stone slabs**
- **Non-load-bearing facades** with a cohesion strength of **less than 0.08 N/mm<sup>2</sup>**

**8.2. Anchors to be used for new facade and old undamaged facade**

-**Koelner KI-10** anchors and **Tytan F-D-KLP** anchors with PVC nail are to be used on **new facades and old facades that are neither damaged nor porous.**



Koelner KI-10 Anchor



Tytan F-D-KLP Ankle

**8.3. Anchors to be used for terracotta block facades and old, damaged facades**

-**Wkret-Met LMX-10** anchors and **Wkret-Met Eco-Drive 8** anchors with steel nail and screw are for use on terracotta block facades and old facades that are damaged and porous.



Wkret-Met LMX-10 Anchor



Wkret-Met Eco-Drive 8 Anchor

**8.4. Doweling system to be used for doweling Adam Matériaux HD EPS  
on wooden facades**



Adam Matériaux EPS HD installation on a wooden facade

Rawplug KC cap rosette as screw-in  
dowel for wooden facades

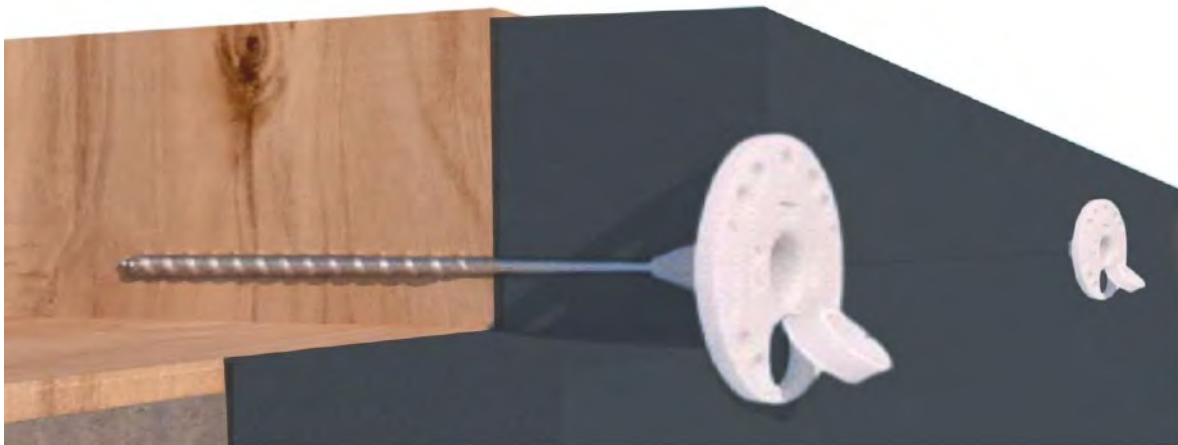

Rawplug KC rosette-cap diagram with wood screws for EPS HD wooden facades ADAM Matériaux

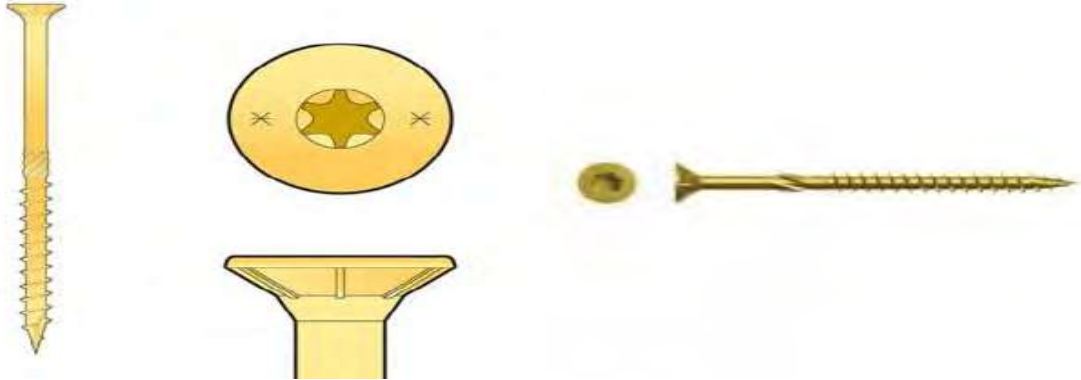

Rawplug TW R-TS wood screws

and Domax CS and CT

to be used to fix Rawplug KC caps **with a minimum of 6 screws/m<sup>2</sup>**

**8.5. Using the orange strawberry + EPS caps to close the ankles:**



Orange strawberry to down the ankles in the EPS



EPS 65mm plug diagram for EPS HD dowel ADAM  
 Matériaux

Installation of EPS plugs on the dowels placed in the Adam Matériaux EPS HD insulation using coring carried out **with the orange cutter**.

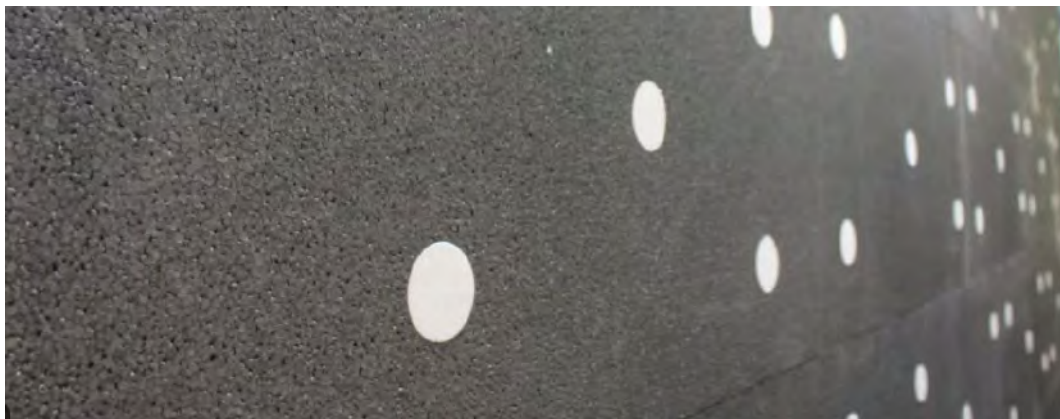

The use of **EPS plugs** on the **ankles** also prevents **large energy losses** through the ankles.



**After installing the dowels and EPS plugs on which each EPS plug must be glued (dressing)**, that is to say cement each EPS plug with Adam Matériaux grey or white glue before coating the Adam Matériaux HD EPS panels.



Gluing the caps before coating the Adam Matériaux HD EPS panels



You can now coat **Adam Matériaux EPS HD insulation** with Adam Matériaux reinforcing mesh!

## **9. Coating of Adam Materiaux HD EPS and installation of Adam Materiaux reinforcement mesh**

### **RECOMMANDATIONS:**

-For **the coating of Adam Matériaux EPS HD panels** when installing the Etics facade and Adam Matériaux plaster system, it is recommended to coat with **a Kubala 0202 notched plaster of 6x6mm**, with **a minimum thickness of 3mm and a maximum of 6mm** per layer of Adam Matériaux grey or white glue.



Adam Materiaux 145 gram reinforcement net



Kubala plaster 0202 serrated 6x6mm



Kubala plaster cast 0401 or 0202

-As already described above, it is **mandatory** to **sand the Adam Matériaux EPS HD panels with the Kubala 0343 or 0344 rasp** before coating with Adam Matériaux grey or white glue.



-It is **mandatory** to respect the water dosage for mixing the Adam Matériaux gray or white glue, i.e. **between 5 and 5.5 liters of water**, mixing **for 3 to 5 minutes**, as well as the duration of its use, i.e. **2 hours**.



The Adam Materiaux net is glued into the glue, which is leveled to obtain a flat surface.

**Coating of Adam Materiaux HD EPS** and installation of **Adam Materiaux reinforcement** mesh of 3 to 6mm per layer.

- Apply Adam Matériaux **grey or white glue** to the Adam Matériaux EPS panels **to a thickness of 3 to 5 mm** and then place the Adam Matériaux reinforcement mesh in the Adam Matériaux glue “**wet on wet**” by **embedding** the Adam Matériaux reinforcement mesh in the middle of the Adam Matériaux glue and finally, **crush** the Adam Matériaux glue **with Kubala 0401 or 0202** plaster to obtain a flat surface.

- All Adam Materials reinforcement mesh strips **must overlap by at least 10cm following the orange line** on **both sides** of the Adam Materiaux 145gram reinforcement mesh (= 10% overlap).

**To position the Adam Matériaux reinforcement net** in the right place in the outer half of the thickness of the base coat, i.e. around the middle for thin coatings and two-thirds for thicker coatings, it is recommended to apply **a second layer of Adam Matériaux gray or white coating glue within 24 hours of applying the first layer of Adam Matériaux gray or white coating glue** to use the “**wet on wet**” method and respecting the overlap of **at least 10cm** following the orange line **on both sides of the Adam Matériaux 145 gram reinforcement net**.

The coating of the Adam Materiaux HD EPS panels is now complete!

## **10. Installation of the LS-VH stop angle with reinforcement net to be placed against the frames before starting the work of installing the Adam Materiaux EPS insulation Facade**

The **LS-VH 06 6mm** angle with a 10cm reinforcement net should **be placed at least 2cm from the edge of the window frames**.

The LS-VH 06 6mm angle is available in **white or Anthracite RAL 7016**.

Packaging = **Length = 2.4 meters - Thickness = 6mm - 30 angles/bundle - 72 meters/bundle**

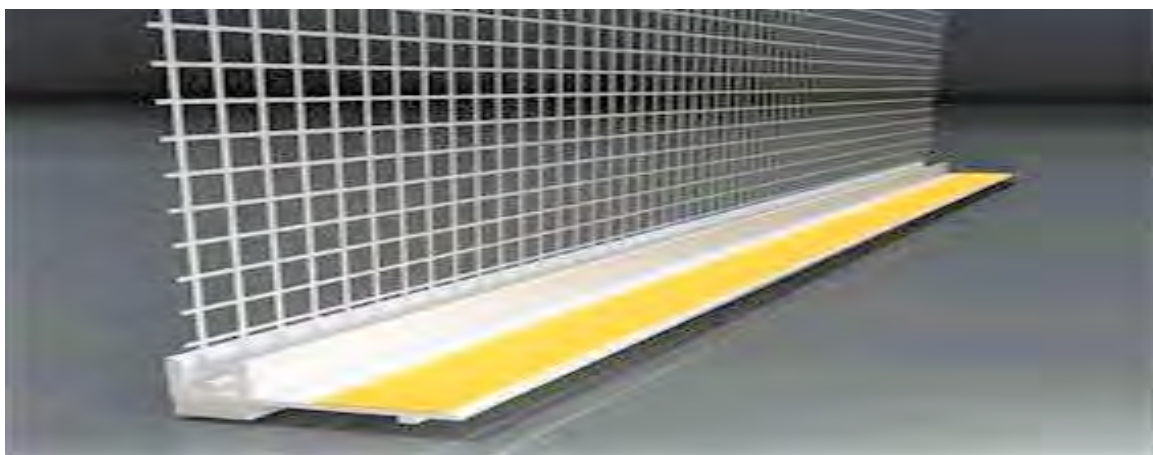

LS-VH 06 6mm angle to be placed at least 2cm from the edge of the window frames



Height view of the LS-VH 06 6mm angle iron



LS-VH 06 6mm angle iron, Anthracite RAL 7016 color



Installation of the LS-VH 06 6mm angle iron **at least 2cm from the edge of the window frames**



**Installation of LS-VH 06 6mm corners** at least 2cm from the edge of the window frames



Installation of LS-VH 06 6mm corners **at least 2cm from the edge of the window frames**

**Recommandations:**

- When placing the LS-VH 06 6mm angle iron with 10cm reinforcement net **on the fixed frames of the chassis**, the LS-VH 06 angle iron must be assembled correctly with the other LS-VH 06 angles found on the other fixed frames of the chassis.
- The LS-VH 06 6mm angle iron with 10cm reinforcement thread must be placed **at least 2cm from the edge of the frame frames.**
- The LS-VH 06 angle iron is fitted **with a self-adhesive strip** which must **therefore be stuck directly onto the fixed frames of the frames.**
- It is recommended to thoroughly **clean the frame frames before** installing the LS-VH 06 corner pieces **to ensure proper bonding of the LS-VH 06 corner piece.**
- It is recommended to place the LS-VH 06 angles **between 3 and 5 cm from the edge of the fixed frames of the frames.**
- It is recommended to use a spirit **level to level** the LS-VH 06 angles
- After the Adam Matériaux plastering has been completed and the frames have been cleaned, **the remaining "stick"** of the LS-VH 06 angle iron must be removed and if all the work has been carried out correctly, **no silicone joint** must be placed **between the LS-VH 06 angle iron and the frame.**

**11. Installation of the pre-compressed sealing strip  
(compriband) Illmod TP600 on the fixed frames of the frames  
next to the LS-VH 06 angles**

This **illmod TP600** corner bead is **to be placed on the frame frames** next to the LS-VH 06 corner bead, **on the facade insulation side.**  
The Illmod TP600 compression gasket **will be placed next to the LS-VH 06 6mm corner bead, on the facade insulation side.**



**Illmod TP600 pre-compressed** sealing strip (compriband)

Installation of the pre-compressed sealing strip (compriband) **Illmod TP600** on the fixed frames of the frames next to the **LS-VH 06** angles, on the side of the facade insulation.



Installation of the pre-compressed sealing strip (compriband) **Illmod TP600** on the fixed frames of the frames next to the **LS-VH 06** angles, on the side of the facade insulation.

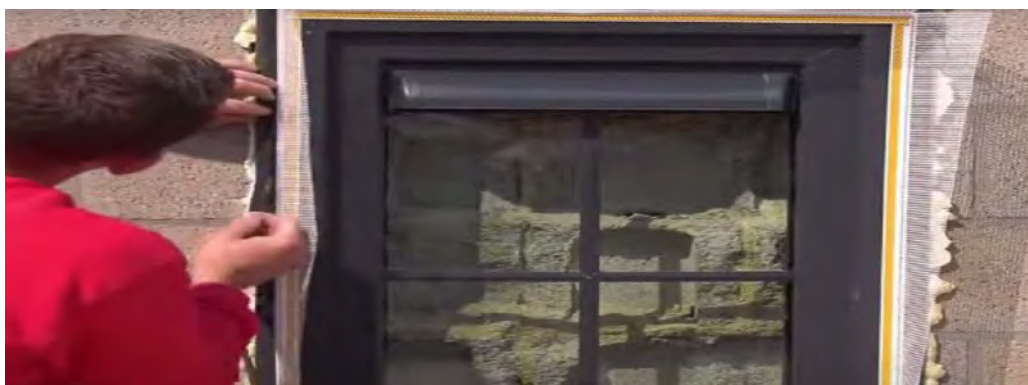

Pose de la bande d'étanchéité précomprimée (compriband) **Illmod TP600** sur les dormants fixe des châssis à côté des cornières **LS-VH 06**, **côté de l'isolant de façade**.



**As a reminder, at this stage of the work, the frames must be protected:**

-Plastique bleu 60 cm x 75 mètres/ rouleau 45m<sup>2</sup> autocollant pour protection châssis :



- **48mm orange tape** for chassis protection:



It is not a big job **to protect the frames** but if it is not done, it may be necessary to replace some frames after the facade and plastering work because they are so damaged by the glue and plaster.

**You can now place the ALU or PVC starting angle on the base laid in Adam Matériaux EPS HD and start insulating the facades with Adam Matériaux EPS facade!**

**12. Installation of the Adam Matériaux 032 or 031 EPS which starts either on a starting angle complex in ALU LO-AL or a starting complex in PVC (as for the start of the HD EPS) – see pages 12 to 17**

EPS HD ADAM Matériaux



On Adam Matériaux EPS HD insulation, it is mandatory to install [ILLBRUCK TP600 compression band](#) (see page 9)

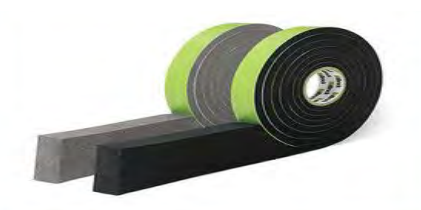

**ILLBRUCK TP600** compression band

EPS HD ADAM Matériaux



Installation of **compriband joints** before installation of the starting angles on the Adam Matériaux HD EPS

When installing the **ALU or PVC starting angles**, **all the recommendations given** for the start of Adam Matériaux HD EPS must be followed. See pages 12 to 17





Application of Adam Materiaux **gray glue** for bonding EPS  
Adam Materiaux

For bonding Adam Materiaux EPS, **all recommendations given** for bonding **Adam Materiaux** HD EPS must be followed. *See pages 24 to 27.*



Installation of EPS 032 Adam Materiaux insulation - EPS HD Adam Materiaux

### **13. Data, thicknesses, packaging and dimensions of the Adam Matériaux 031 and 032 facade EPS**



**EPS Graphite** Adam Materiaux 031 and 032



## Technical note on the Adam Matériaux facade and plaster system

- For the installation of the Adam Matériaux Etics facade and plaster system, Adam Matériaux markets its EPS Graphite insulation **with straight edges** to limit insulation waste during construction. Indeed, mortise and tenon insulation generates a large volume of waste. However, upon order, we deliver your Adam Matériaux EPS Graphite insulation **with mortise and tenon**. The joints between each Adam Materials Graphite EPS insulation panel **must be sealed using Adam Matériaux PUR foam**.
- Adam Matériaux EPS panels measure **100x50cm**.
- Adam Matériaux EPS panels are available in thicknesses from **1 to 30cm**.
- Adam Matériaux EPS panels are available with graphite **lambda 031 and 032**.
- Adam Matériaux EPS panels are available with straight or **mortise-and-tenon edges**.  
**Do not store EPS Adam Matériaux Graphité 031 and 032 in direct sunlight or frost**, for several days. Indeed, with the effect of the sun (UV) or during winter weather conditions, Adam Matériaux 031 and 032 EPS and EPS HD can deform (**banana effect**).
- Panel dimensions = 1000mm x 500mm
- Packaging for straight-edged panels, thickness in mm

**Nombre de panneaux/ ballot    Number of m<sup>3</sup>/bale    Number of m<sup>2</sup>/bale**

mm	10	20	30	40	50	60	70	80	90	100	110	120	130	140	150	160	170	180	200
panels	60	30	20	15	12	10	8	7	6	6	5	5	4	4	4	3	3	3	3
m <sup>3</sup>	0,3	0,3	0,3	0,3	0,3	0,3	0,28	0,28	0,27	0,3	0,275	0,3	0,26	0,28	0,3	0,24	0,255	0,27	0,3
m <sup>2</sup>	30	15	10	7,5	6	5	4	3,5	3	3	2,5	2,5	2	2	2	1,5	1,5	1,5	1,5

mm	210	220	230	240	250	260	270	280	290	300									
panels	2	2	2	2	2	2	2	2	2	2									
m <sup>3</sup>	0,21	0,22	0,23	0,24	0,25	0,26	0,27	0,28	0,29	0,30									
m <sup>2</sup>	1	1	1	1	1	1	1	1	1	1									

## 14. Bonding of EPS Adam Facade Materiaux

You must also follow all the recommendations already given for bonding Adam Materiaux HD EPS - see pages 24 to 27 - for bonding the EPS Adam Facade Materiaux either:

- The facade must be **clean and adherent**.
- Respect the mixing water dosages for Adam Matériaux gray or white glue.
- Respect the **gluing methods**, either full gluing or **gluing by pads**.
- Bonding only with **Adam Materiaux foam** for **wooden and smooth concrete** facades.
- Respect **the plumb line of Adam Matériaux EPS insulation** even if **the facade is not straight**.
- Close **all joints between the Adam Materiaux** EPS panels with Adam Materiaux foam.
- Respect **the recommended times before sanding** the Adam Matériaux EPS panels with the Kubala sandpaper.
- Sealing **all joints between Adam Materials EPS panels** with Adam Materiaux **PUR foam**:



The following recommendations should be added for bonding Adam Matériaux de façade EPS when installing the Etics façade and plastering system.

- Respect the placement directions of the Adam Materiaux EPS, especially **around windows and doors and at the junction of the starting angles**.
- **Adam Matériaux EPS insulation** must be installed **in a staggered pattern**:



Installation of Adam Matériaux EPS insulation in a staggered pattern, in the correct manner

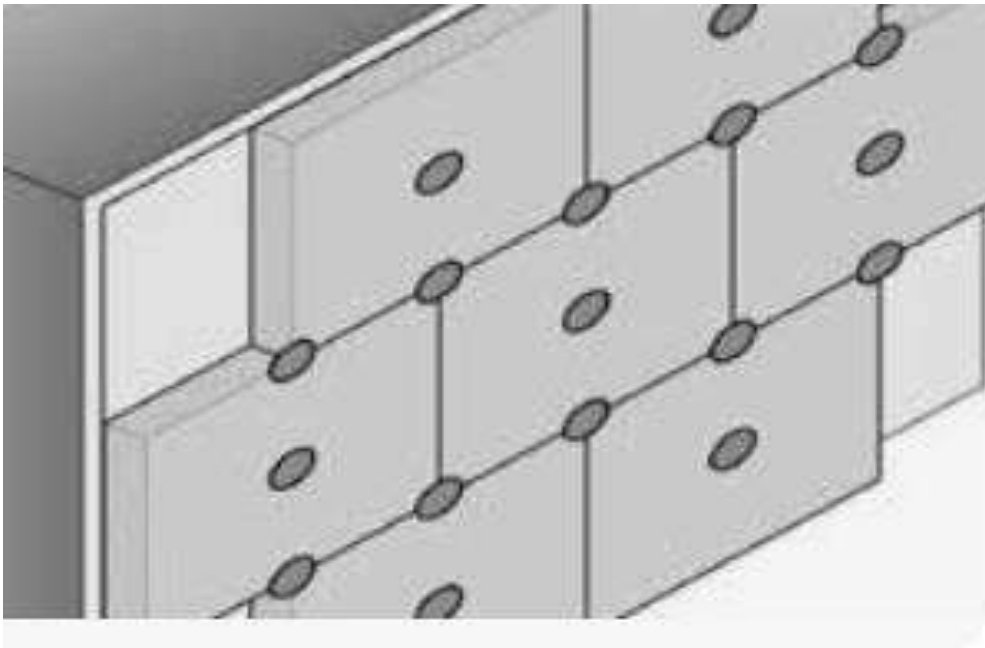

**L-shaped** cutouts should be provided **around windows and doors.**

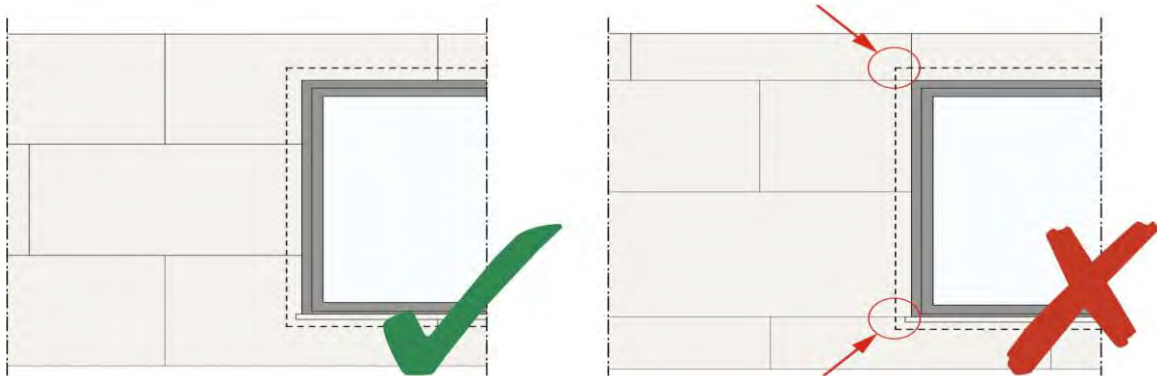

Placement of Adam Matériaux EPS panels **in a single piece** in the bay corners to limit **the risk of cracking**

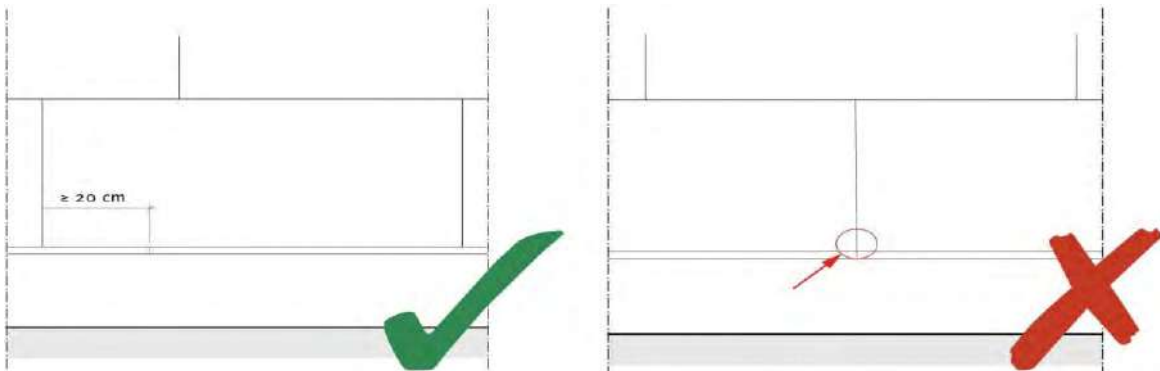

Absence of joint between Adam Matériaux EPS panels at the junction of **the ALU starting angle or the PVC angle**

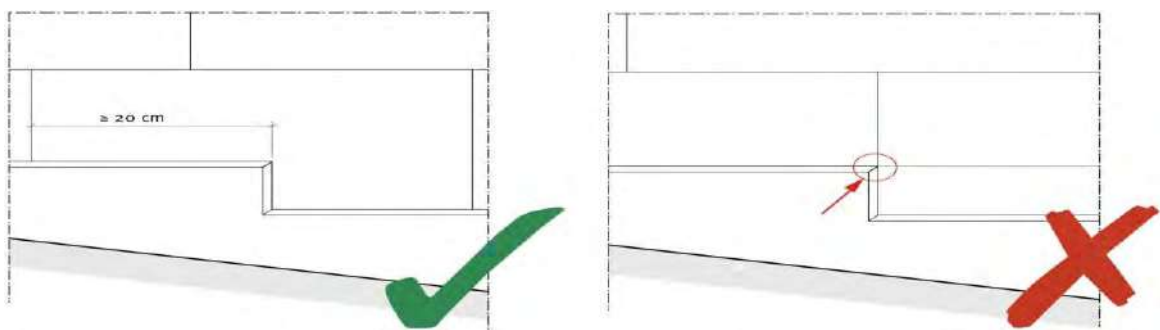

Source= Pages 84, 89 and 94 of NIT 257 from Buildwise

Correct installation of Adam Matériaux EPS **in one piece around windows and doors** Placement of Adam Matériaux EPS panels in **one piece in the corners of windows** to limit **the risk of cracking**.



If the installer does not respect the direction of placement of the Adam Matériaux EPS around the windows and doors and on the starting angles, cracks will appear in the weeks or months following the Adam Matériaux facade and rendering work:



**INCORRECT installation** of Adam Matériaux EPS which **will cause cracks after work.**

Here is what quickly happens if **the placement directions** of the Adam Matériaux EPS **are not respected** around the windows:



**Cracks** around windows created by **not placing Adam Matériaux EPS panels** in “L” shape around windows **around the corners of doors and windows**

**15. Respect for the plumb line of the Adam Matériaux EPS even if the existing facades are not straight when installing the Adam Matériaux Etics facade and plaster system**

**Indeed, it is very important to place the Adam Matériaux EPS plumb on all facades even if:**

- The facades are not straight, even in new construction.
- The window sills were poorly positioned.
- The roof overhangs were poorly calculated.
- The gutters and downspouts were poorly positioned.
- The shutters and windows were poorly positioned.

If the facade specialist does not work straight and "follows" uneven facades, it is this facade contractor who **will "take responsibility" for all the defects.**

**In the event of any of the above defects**, the client must be asked to **correct all defects** before the **start of the Adam Matériaux facade and rendering work**. It is important to position the Adam Matériaux EPS using a level and with the help of ropes to install the Adam Matériaux EPS insulation straight and level.



Using a **level** for laying Adam Matériaux EPS

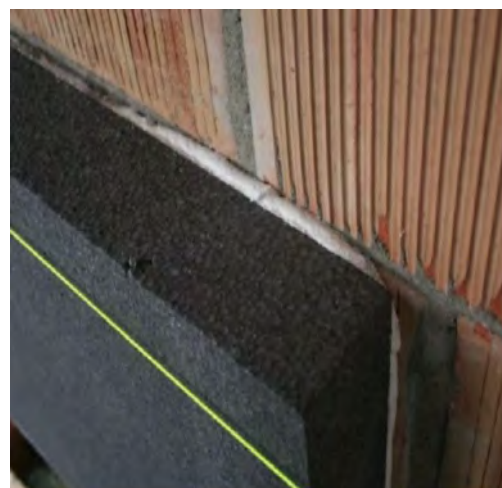

Using a **rope** for laying EPS

Overhanging roofs and **poorly placed shutters**



Overflowing **well-placed shutters**



**Well-placed** roof overhang



**Badly placed** roof overhang



- **10mm out-of-plumb facades can be repaired over 2 meters** with Adam Matériaux **gray or white glue** without doweling on new facades. For out-of-plumb areas of **10 to 20mm over 2 meters**, doweling will be **mandatory** even on new facades.

- Above **20mm out of plumb per 2 meters**, it will be necessary to use **different thicknesses** of insulation to ultimately maintain an absolutely flat and straight insulated facade. **This specific case** must be the subject of a precise study and an agreement with the project owner (client) **before the start of installation** of the Etics facade system and Adam Matériaux rendering. The facade specialist cannot be held responsible for **the flatness of the facades at the start** of the work. Indeed, correcting the out of plumb with Adam Matériaux EPS in different thicknesses takes time and it is therefore necessary to provide a supplement before the start of the work.
- After applying the gray or white Adam Matériaux glue to the EPS, press the Adam Matériaux EPS directly onto the facade, plumb and level, **offsetting the joints of the Adam Matériaux EPS boards** by **at least 10 cm**.
- After installing the Adam Matériaux Graphite 031 or 032 EPS, quickly apply the Adam Matériaux **gray or white glue** for coating the Adam Matériaux EPS **to avoid damage from frost and/or the sun in the days following the installation** of the Adam Matériaux EPS, especially during hot summer periods and winter periods.



## **16. Connection of the Etics system of Adam Matériaux facades and plasters to the side edge (gable wall) of a sloping roof and to the upper facade profiles**

As a reminder, **it is mandatory to place a lmod TP600 compression seal:**

- Between the Adam Matériaux EPS HD insulation and the **aluminum or PVC starting material**
- Between the Adam Matériaux EPS HD insulation and the **aluminum or PVC starting for flat roofs, sloped roofs, and balcony and terrace connections.**
- Between the Adam Matériaux EPS and the facade around the frames before **the LS-VH06 angle on the insulating side**
- Below
- Or by placing **the LX-LPE angle** below the window sill
- On the sides of the window sill or by placing **the LX-SPP angle** below the window sill
- Around **the Blochets VARIQ, VARIR, UMP, ...**
- **Between the Adam Matériaux EPS insulation** and the upper part of the facades such as **as wood, concrete, PVC, etc.**
- Around any element not part of the Etics Adam Matériaux system.
- Between the Adam Matériaux EPS insulation and parts of the building **that are not to be insulated.**
- Between the Adam Matériaux EPS insulation and **the roof edges and wall coverings.**
- Between the Adam Matériaux EPS insulation and **openings and fasteners.**

It is therefore necessary to provide a compressive joint between the Adam Matériaux EPS insulation and the upper part of the facades such as wood, concrete, PVC, etc.



Raccord à la rive latérale d'une toiture à versants (vue de l'isolant interposé avant les travaux de façade).



**Diagrams:**

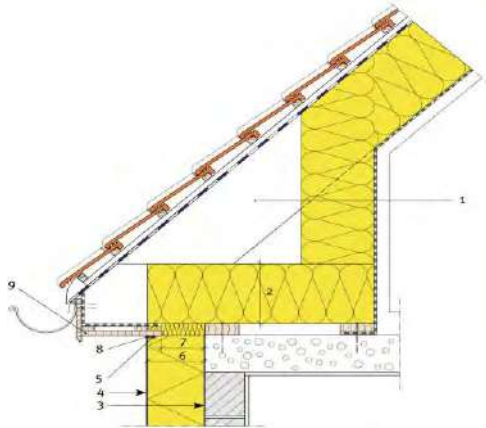

Connection of the Etics and Adam Matériaux plaster to the edge of the Etics of facades and Adam Matériaux plaster to the edge of the lower slope of a sloping roof (case where the Etics comes up against the overhang)

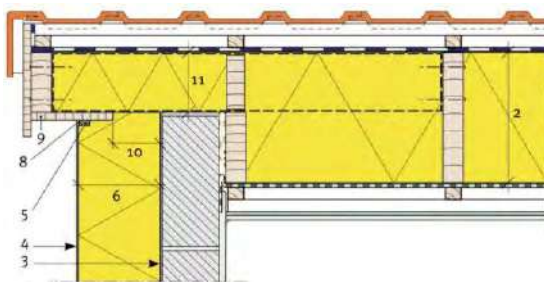

8. **TP600 compression joint**

Source Pages: 67 and 68 of Buildwise's NIT 257

**17. FIRE BARRIER: when installing the EPS of the Etics facade system and Adam Matériaux rendering**

- Single-family homes are not subject to any requirements.
- Fire barriers must be installed for buildings between 18 and 25 meters.
- When performing facade and rendering work on tall, terraced houses, etc., and depending on the region or municipality where the work is located, *the architect or project owner will prescribe the installation of a "fire barrier,"* which can be installed with rock wool such as Rockwool Frontrock:
- **See NIT recap 17, page 19**



## **18. Installation of aluminum or blue stone window sills during the Etics facade and Adam Matériaux rendering system**

It is recommended to follow the installation methods for aluminum and blue stone thresholds with side and rear elevation, and to use the different angles in the Etics facade and Adam Matériaux rendering system.

The window sills and all the necessary corner brackets must be placed after the Adam Matériaux EPS has been installed, as **out-of-plumb** conditions are quite common in renovations and even in new constructions, and BEFORE the Adam Matériaux EPS insulation panels are coated.

It is recommended **to install the frames with a recess**. Installing frames **without a recess is not recommended**.

It is recommended that **aluminum sills extend 2 to 3 cm beyond** the finished (plastered) facade.

It is recommended that **bluestone sills extend 4 to 5 cm beyond** the finished (plastered) facade.

**It is recommended to install aluminum thresholds with Adam Matériaux PUR foam. It is recommended to install bluestone thresholds with Flex adhesive or Adam Matériaux PUR foam.**



**It is mandatory** to use the **LX-SPP angle for the sides of the thresholds:**

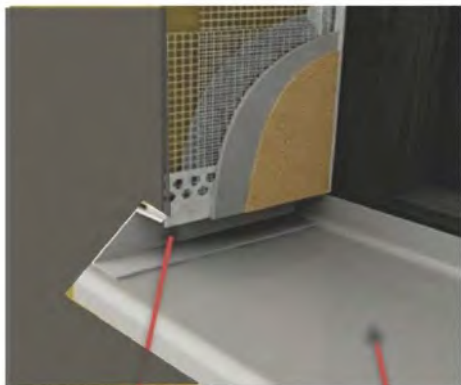

LX-SPP Corner for lateral raising of thresholds

Aluminum threshold (RAL 7016, 7039 and very popular white)



LX-LPE corner installation below thresholds with integrated compression joint

**It is mandatory** to use **the LX-SPP angle iron for the side extensions of the thresholds.**



**LX-SPP**

**It is mandatory** to use **the LX-LPE angle for the underside of the thresholds:**

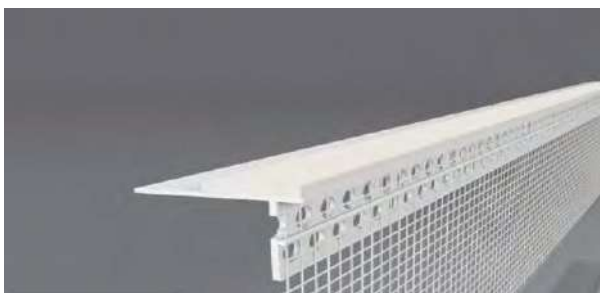

**LX-LPE**

These 2 angles are fitted **with an integrated compression seal**

### **Recommandations:**

-When placing the LX-SPP angle iron on the tops of the aluminum or bluestone sills, **it must be correctly assembled with the LS-VH angle** iron glued to the fixed frame of the chassis.

If **these angles are not placed by the contractor**, the following problems may occur very quickly, **namely streaks on the plaster**:



It is also recommended to install **Koelner support reinforcement brackets** below the aluminum and blue stone thresholds.



Connection between an Adam Materiaux ETICS and a frame placed on a thermally insulating construction block:

1. Adam Materiaux EPS insulation panel
2. Adam Materiaux primer and render
3. LX-SPP angle for lateral sill raising
4. Frame thickness
5. Depth of the batten (> 4 cm)
6. Length of the batten (> 2 cm)
7. Below thresholds with LX-LPE angle
8. LK-PVC corner bead with 10x10cm glass mesh
9. Aluminum window sill
10. Stop profile (optional)
11. LS-VH06 flexible sealing gasket
12. Adam Matériaux gray or white adhesive
13. Pre-frame
14. Adam Matériaux PUR foam
15. Rear riser (heel)
16. Insulating building block
17. TP600 compriband gasket

Source: Pages 56, 57, 58, 59 and 60 of Buildwise NIT 257

**Different ways to install windows in the facade**  
**- NON-CENTRALLY MOUNTED CHASSIS**

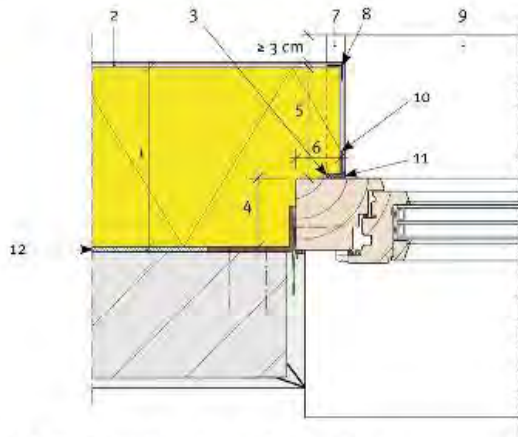

A. Horizontal section - chassis without front frame  
 (only in low-noise environments)

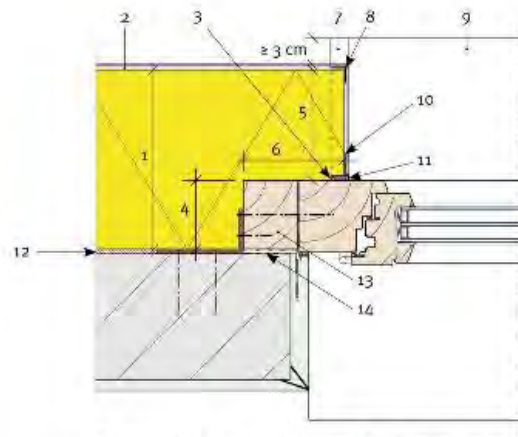

B. Horizontal section - chassis with front frame

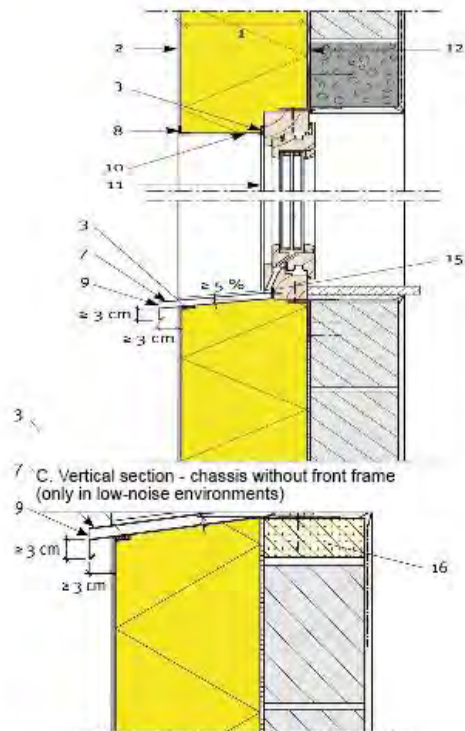

C. Vertical section - chassis without front frame  
 (only in low-noise environments)

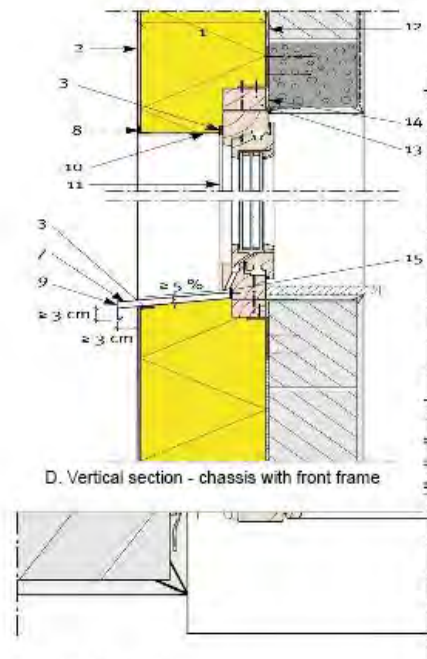

D. Vertical section - chassis with front frame

A. Horizontal section

**- FRAME INSTALLED IN THE WALL PLAN**

## **19. Installation of LA-R corner tissues in the corners of windows and doors on the Adam Matériaux facade EPS**

It is mandatory to use the **LA-R 350x300x200mm corner strip**, which is already pre-cut and has the finished shape, to ensure the continuity of the reinforcement mesh in the internal corners of window and door frames when installing the Adam Matériaux Etics facade and plaster system.

As a reminder, **these Adam Matériaux 145-gram corner strips or reinforcement mesh strips** must also be installed at the junction of the aluminum and PVC starting corners.

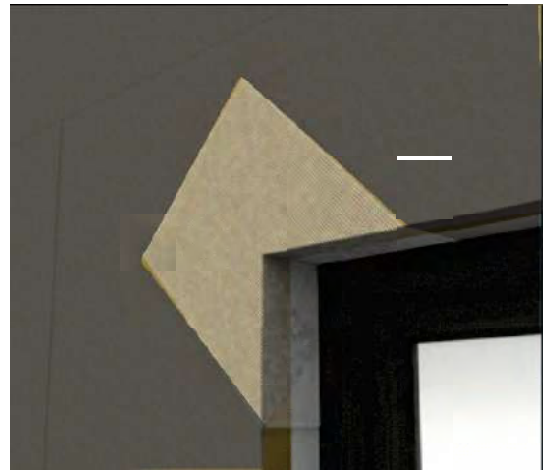
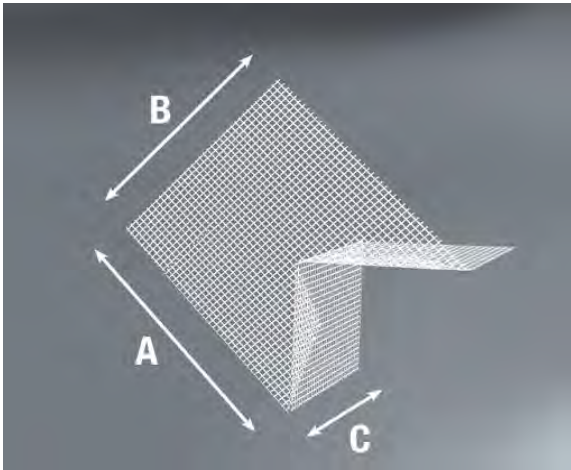

LA-R corner handkerchief



Above are examples where **the LA-R 350x300x200mm corner handkerchiefs** have been correctly placed and guarantee maximum longevity of the Adam Matériaux Etics facade and plaster system.

This is what quickly happens if the LA-R 350x300x200mm corner tissues are not placed around the corners of doors and windows:

**Cracks around windows created by not placing LA-R 350x300mm 4x4mm corner tissues (see below paragraph “Adam Materials EPS coating”) around the corners of doors and windows.**



## 20. DOWELING of the Adam Matériaux facade EPS

All the recommendations already given for the DOWELING of Adam Matériaux HD EPS - see pages 27 to 32 - must also be respected when DOWELING Adam Matériaux facade EPS:

- Wait **2 to 10 days** after gluing the Adam Matériaux EPS depending on **the weather conditions** before anchoring with the **Koelner KI-10, Tytan F-D-KLP, Wkret-Met LMX-10, Wkret-Met Eco-Drive 8** fixing anchors which will serve as **a definitive fixing** for the Adam Matériaux EPS insulation and avoid any **risk of detachment**.
- Installation of **at least 6 dowels/m<sup>2</sup>** for the installation of Adam Matériaux **plaster**.
- Install **at least 8 dowels/m<sup>2</sup>** if you are using **brick tiles**.
- Obligation **to use dowels on old facades** and on facades that are not plumb.
- Use **the orange cutter** to integrate the dowels into the Adam Matériaux EPS insulation and **avoid “ghosting”** the dowels and avoid energy losses through the dowels.
- Use **the EPS plugs** to “drown” the dowels in the holes created by the orange cutter.
- **Respect the length** of the anchors according to the thickness of the insulation installed as well as the condition of the facades. Choose **an anchor 4 to 6 cm larger than** the thickness of the EPS Adam Matériaux Example: to anchor an EPS 14 cm thick, you need **18 or 20 cm anchors**.





EPS plugs placed in the Adam Matériaux EPS insulation **BEFORE** the installation of “bandages” using Adam Matériaux **gray or white glue**.



Applying “bandages” using Adam Matériaux **gray or white glue** to close the EPS caps placed to “drown” the fixing dowels.

-Use **Rawplug KC caps** and wood screws for doweling **on wooden facades**: -



**Rawplug KC cap rosette** as a screw-in dowel **for wooden facades**.

If you **do not use the orange cutter to integrate the dowels** into the Adam Matériaux EPS insulation, **this will cause** the “ghosting” phenomenon:



Insulated facade with **the dowels visible** under the **low sun** because the dowels were **not integrated** into the Adam Matériaux EPS insulation with **EPS caps** but the dowels were only hammered in. **The end result is not pretty**

## **21. Installation of the various angles and blocks provided in the Etics facade and Adam Matériaux rendering system**

### **21.1.1 Installation of the corner bracket for windows, doors and facade corners LK PVC Premium 2.5 meters with 10x10cm reinforcement net on the EPS Adam Matériaux**

This 2.5 meter **LK PVC Premium** angle with 10 x 10 cm reinforcement mesh is to be **placed at the corners of frame insulation and at the corners of the facade.**

**Packaging = Length = 2.5 meters - 50 corners/bale - 125 meters/bale – 10x10cm**

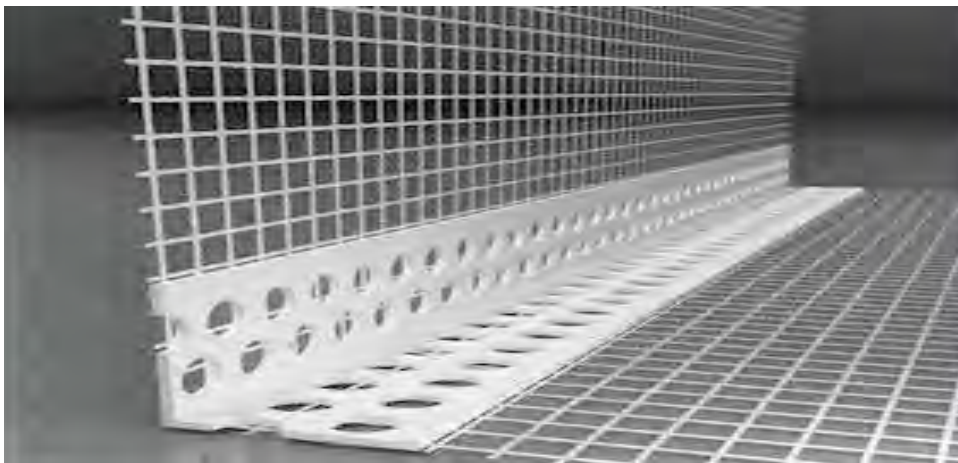

LK PVC Premium 10x10cm frame corners and facade corners



**Applying Adam Matériaux glue to the corner of the facade**

Applying Adam Matériaux **grey or white glue** before installing the **LK PVC Premium 10x10cm corner bead at the corner of the facade**



**Cutting and installing the 10+10 cm  
corner bracket at the corners of the facade**

Pose de la cornière d'angles de châssis et coins de façade **LK PVC Premium 10x10cm** au coin de la façade



**Adjusting the levels of the corner bracket 10+10 cm**

Using a **spirit level** to install the **LK PVC Premium 10x10cm corner bead at the corner of the facade**



Fixing the LK PVC Premium 10x10cm corner to the corner of the facade with Adam Matériaux grey or white glue



Same technique for installing the LK PVC Premium 10x10cm facade corner bracket around windows and doors.

LK PVC Premium 10x10cm corners are placed around the window and facade corners.

### Recommandations :

- Use Adam Matériaux grey or white glue to install the 2.5-meter LK PVC Premium corner bead with 10x10cm thread.
- Place the LK PVC Premium corner bead on the insulation corners, facade corners, and frame surrounds, correctly assembling it with the other LK PVC Premium corner bead on the other frame corners.
- When placing the LK PVC Premium corner bead on the facade and frame corners, it must be correctly assembled with the LE-G (flap) corner bead on the aluminum starting corner bead or the LW206 PVC starting corner bead.
- Use a spirit level to level the LK PVC Premium corner bead.

**21.1.2 Installation of the corner bracket for windows, doors and facade corners LK-VH PVC 2.5 meters with reinforcement nets and guide for laying glue and plaster without overflows**

Packaging = Length = 2.5 meters - 25 corners/bale - 62.5 meters/bale

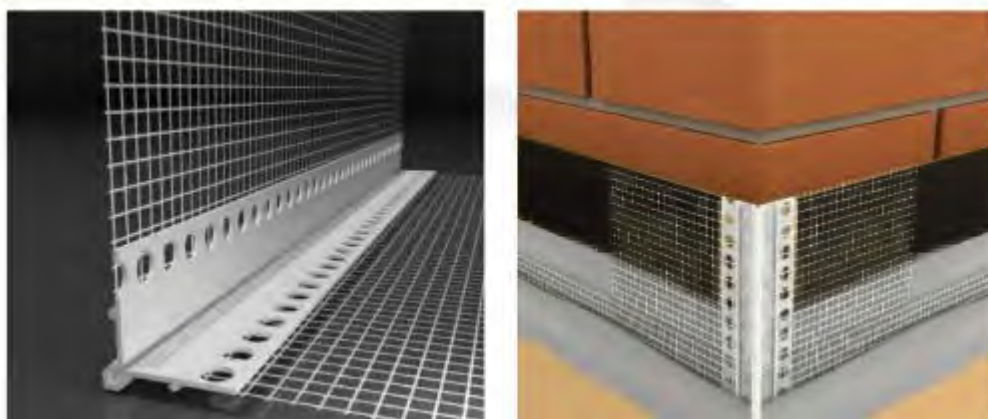

The same recommendations apply to the LK-VH PVC corner bead as for installing the LK PVC premium corner bead.

Using this LK-VH PVC corner bead will ensure perfectly straight edges on windows, doors, and facades, without any overhangs or smudges of plaster or adhesive.

This LK-VH PVC angle replaces the LK PVC Premium angle for optimal results.

**21.2. Installation of the “Balcony” LTD 2.5 meter angle with water drop with 10x10cm reinforcement net on the EPS Adam Matériaux**

This LTD 2.5 meter angle with 10 x 10 cm reinforcement net is mandatory to place when you need a drop of water on your corner angle such as on the corners of balconies, terraces, lintels, edges, wall coverings, etc.

Packaging = Length = 2.5 meters - 25 corners/bale - 62.5 meters/bale – 10x10cm



LTD Corner for balconies, lintels, ledges, terraces, etc.



**Recommandations:**

- Use **Adam Matériaux gray or white glue** to install the LTD corners.
- LTD corners must be installed **at the corners of balconies, lintels, ledges, terraces, etc.**
- When installing **the LTD corner on the corners of balconies, lintels, ledges, terraces, etc.**, it must be correctly assembled with the other LTD corners located on the other corners of the frames.
- Use a **spirit level** to level the LTD corners.

**21.3. Installation of the 2 meter LCL stop angle with 10 cm reinforcement net on the Adam Matériaux EPS**

This **LC-L 2 meter angle** with 10 cm reinforcement net is **to be placed when you need:**

- **Stop the insulating facade** at a corner of the facade instead of installing **the LK-PVC Premium 10x10cm corner bead** with the plastering application on the return.
- **Stop the plastering at facade corners without insulation.**
- **Start the plastering on facades without insulation.**

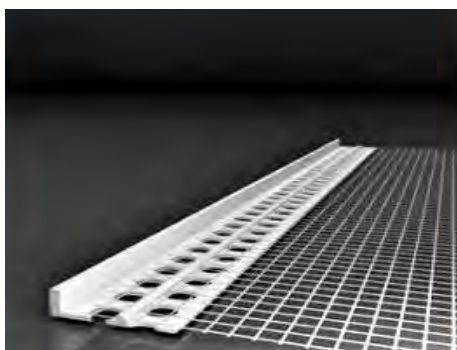

**LC-L stop angle**



**LCL stop angle** placed on a facade **before the application of Adam Matériaux plaster**



Facade corner **WITHOUT LC-L corner**, with the installation of plaster on the return and use of the **LK-PVC Premium 10x10cm corner corner**

**Recommandations:**

- Use **Adam Matériaux gray or white** glue to install the LC-L corners.
- When installing the LC-L corner, **it must be correctly assembled** with the other corners.
- Use a spirit **level to level** the LC-L corners.
- The LC-L corner is mainly used on a facade corner when there is no return (wood cladding on the side, party facade)..

**21.4. Installation of LD-LS PVC expansion angle 90° and 180° on Adam Matériaux EPS**

When carrying out facade and rendering work on tall, semi-detached houses, etc., and depending on the region or municipality where the work is located, **the architect or the project owner** may prescribe the installation of expansion angles which can be installed at a 90° angle or on a flat facade at 180° with **LD-LS expansion angles**.

**- 90° LD-LS expansion angle + 10x10cm reinforcement mesh/piece 2.5 meters**

Packaging = Length = 2.5 meters - 25 angles/bale - 62.5 meters/bale - Reinforcing mesh = 10x10cm

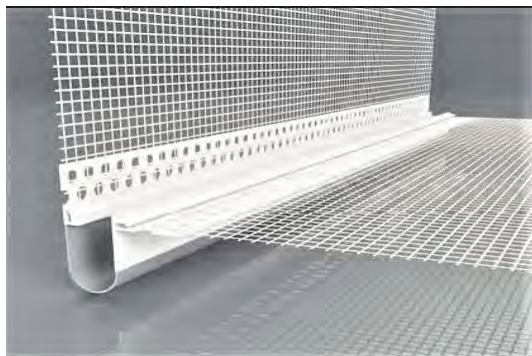

**- 180° LD-LS expansion angle + 10x10cm reinforcement mesh/piece 2.5 meters on EPS Adam Matériaux**

Packaging = Length = 2.5 meters - 25 angles/bale - 62.5 meters/bale - Reinforcing mesh = 10x10cm



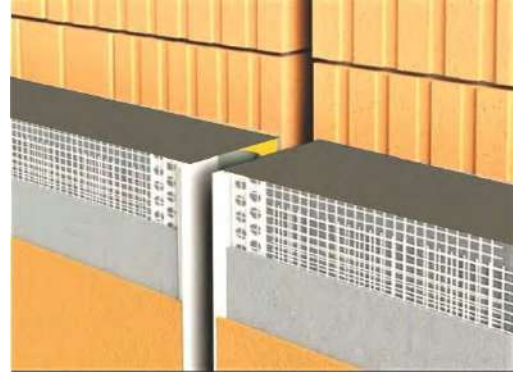
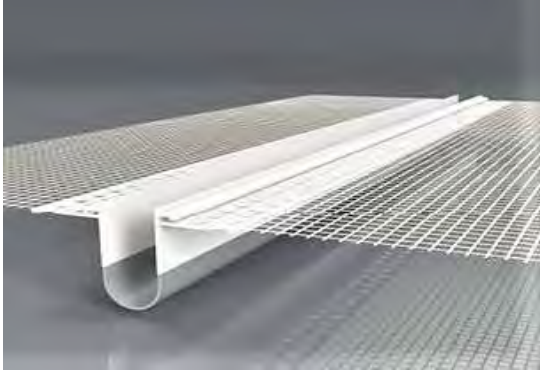

**USE :**

- High-quality junction of different surfaces.
- Protection of the expansion joint against the elements.
- Prevention of moisture penetration under the insulation.
- Profile and profile edges hidden under the plaster.

**Recommandations:**

- Use Adam Matériaux **gray or white adhesive** to install the **LD-LS expansion angles**.
- When installing the **LD-LS expansion angles**, **they must be correctly assembled** with the other angles present in the Etics Adam Matériaux thermal insulation system.
- Use a spirit **level to level** the **LD-LS angles**.
- It is recommended to conduct **an architectural study or measurement** to determine the need for and location of **LD-LS expansion angles**.

**21.5. Installation of blocks before coating the Adam Materiaux EPS panels Facade for the installation of lighting, alarms, taps, downspouts, shutters, railings, sun awnings, ramps, etc.**



After gluing the Adam Matériaux EPS panels, it will be necessary to install **blocks** to secure the new blinds, shutters, and sun awnings after the work on the Adam Matériaux Etics facade and rendering system.

### 21.5.1 Spirals for very light loads

Use **spiral anchors** to fix light items weighing up to 5 kg, such as **downspout attachments, bells, small light fixtures, etc.**

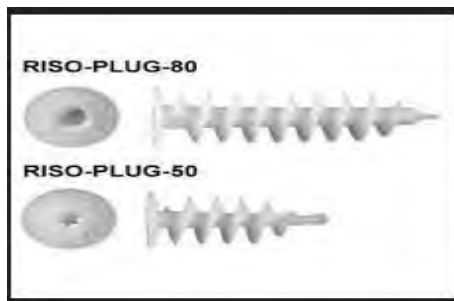

### 21.5.2 VARIQ and VARIR blocks for light and semi-heavy loads

Use the **VARIQ 100x10x10cm** and **VARIR 100x16x10cm** mounting blocks for the thermal bridge-free installation of vertical loads of **less than 40kg**, such as downspout attachments, lights, alarms, cameras, water taps, shutter stops, etc.

Cut a **VARIQ or VARIR** to the thickness of the Adam Matériaux EPS insulation and secure it in the EPS using Adam Matériaux PUR foam before applying the Adam Matériaux gray or white plastering adhesive.

Mark the center of the VARIQ or VARIR with a screw so you can locate it **after the plastering is complete and secure the object.**



**Bloch** VARIS and VARIER



Installation of a custom-made block for fixing the lamp, alarm, attachment, ...



Electical cable passage through the EPS Adam Matériaux

Removal of the Adam Matériaux EPS around the electrical cable before installing the **Variq or Varir block**



Passage of the electric cable through the EPS block Adam Matériaux



Installation of the **VARIQ or VARIR block**

Installation of a **TP600 compression seal** around the **VARIQ and VARIR block**

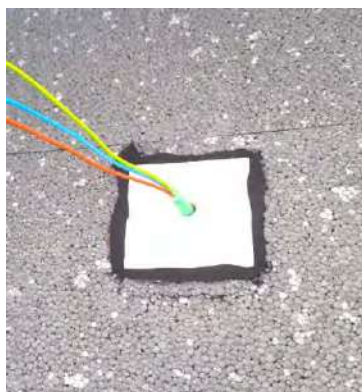
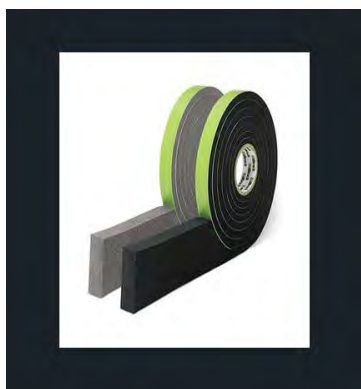

### **21.5.3 UMP blocks for heavy loads**

Use the **UMP 138x138mm mounting block**, 6 to 30cm thick, for the thermal bridge-free installation of **heavy vertical loads weighing more than 40kg** and for personal safety purposes such as **as ramps, barriers, shutters, sun tents, balustrades, etc.**

Fix the UMP block 138x138mm of the same thickness as the thickness of the **Adam Matériaux EPS insulation** placed so that the UMP block is against the existing wall and fix the UMP block with 4 Fischer FUS 10x100mm anchors.'

Mark the center of the UMP block with a screw so you can locate it after applying the plaster **and secure the object.**

Close the various holes with **Adam Matériaux PUR foam.**

As with the VARIQ and VARIR blocks, place a TP600 compression seal around the UMP block.



Installation of railings fixed to the UMP blocks after laying the plaster



#### **21.5.4 TRA-WIK-PU heavy duty corner blocks**

Use the **TRA-WIK-PU Corner Block** for thermal bridge-free installation of **heavy corner loads** for personal safety, such as railings, guardrails, etc.

Attach the **TRA-WIK-PU corner block** of the **same thickness as the Adam Matériaux EPS facade** block so that the **TRA-WIK-PU block** is flush against the existing facade wall, and secure it with **three Fischer FUS 10x100mm metal anchors.**

Use the **TRA-WIK-PU corner block** for thermal bridge-free installation **under heavy loads.**

A **TP600 compression gasket** must be installed around the **TRA-WIK-PU corner blocks**, as it is around the other blocks listed above: Variq, Varir, and UMP.



**21.6. Installation of electrical outlet blocks before coating the EPS panels**  
**We also recommend that you integrate your electrical outlets into the KEZ 301.01 box: Adam Facade materiaux**

We also recommend that you integrate your **electrical outlets** into **the KEZ 301.01 box:**

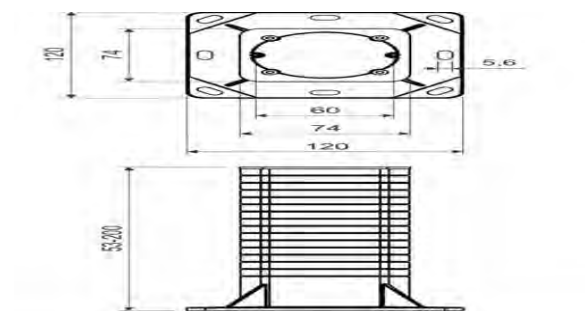
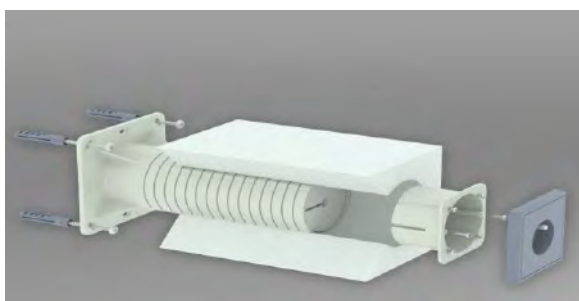

**This KEZ 301.01 box** is ideal for installing electrical outlets in the Adam Matériaux Etics facade and plaster system.

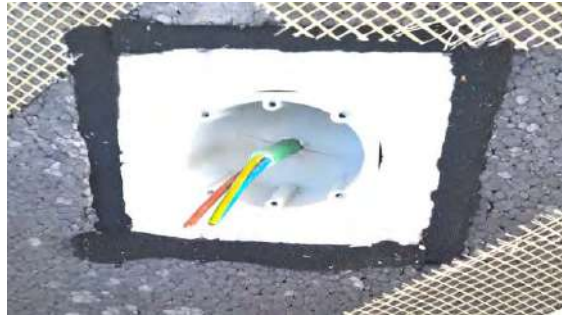

**KEZ 301.01 box** placed in the Etics system of Adam Matériaux facades and plastering with **a TP600 compression** joint around the perimeter of the KEZ electrical block.

## Before coating the Adam Matériaux EPS, you must also check all the points below, already explained in the technical note above.

In addition to all the recommendations already given for coating EPS HD Adam Matériaux see *pages 33 to 34*

**Before coating the Adam Matériaux EPS, you must also check all the points below, already explained in the technical note above.**

### **22.1. Before coating the EPS, check that:**

**The starting aluminum angle LO AL + Insulating Bib LEPS E-G HD 10cm Adam Matériaux are well placed**

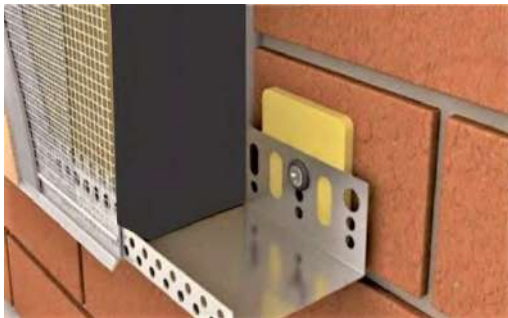

**The PVC angle LW206 10cm + angles LW-L and LZ23 are well placed.**



Adam Matériaux HD EPS Insulation

The connectors between each PVC or ALU starting angle are well placed.



The LX-SPP 10cm angle for the sides of the thresholds is well placed.



The LX-LPE 10cm angle for the underside of the thresholds is well placed.

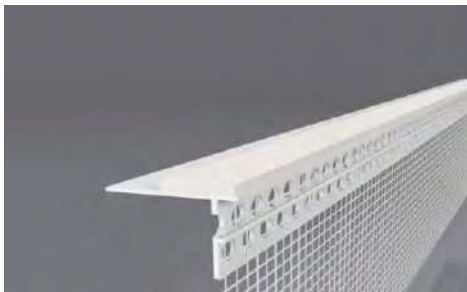

The thresholds respect the following excesses:

Leave the aluminum sills 2 to 3 cm above the finished facade (plaster).

Leave the bluestone sills extend 4 to 5 cm above the finished facade (plaster).



**The LS-VH 06mm 10cm angle iron on the frame frames is correctly positioned:**

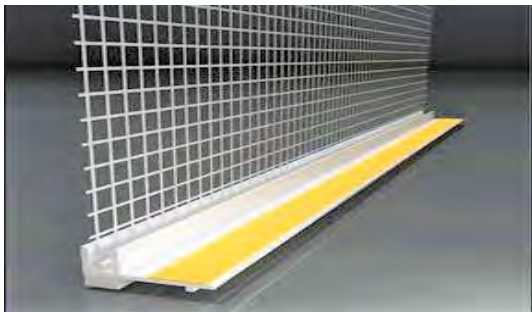

**The LK PVC 10x10cm angle on the sides of the frames and the corners of the facades is well placed or the angle angle with LK-VH guide:**

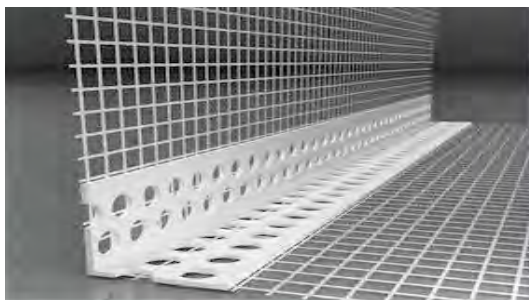

**The LTD Balcony 10x10cm corner on the sides of the frames and the corners of the facades is well placed:**



**The LC-L 10cm angle is correctly positioned:**

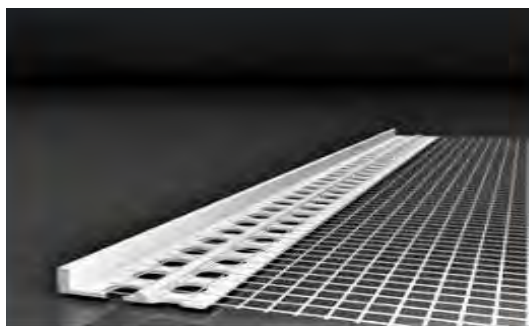



The LC-L 10cm angle iron is used for:

- Stop the insulating facade at a corner of the facade instead of placing the LK-PVC Premium 10x10cm corner bead with the plastering application on the return.
- Stop the plastering at the corners of facades without insulation.
- Start the plastering on facades without insulation.

The LD-LS 90° or 180° angle is well placed:

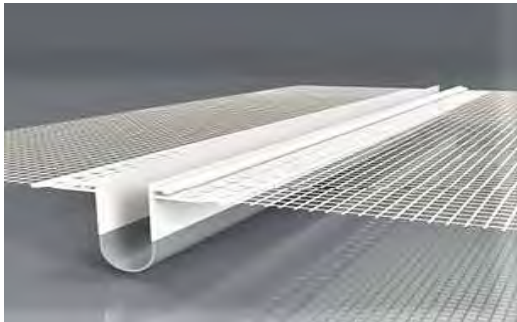

The blocks such as SPIRALE, VARIQ, VARIR, UMP are well placed:



The electrical cables, bells, alarms, taps, are well placed:



The installation of fixing dowels is carried out correctly (5 to 6 dowels/m<sup>2</sup>)

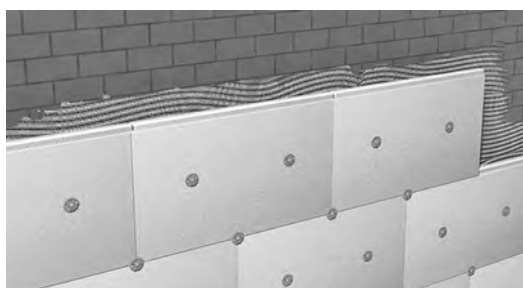

The LA-R 350x330x200mm 4x4mm corner handkerchiefs are well placed at the 4 corners of the frames and between each starting angle in Alu or PVC

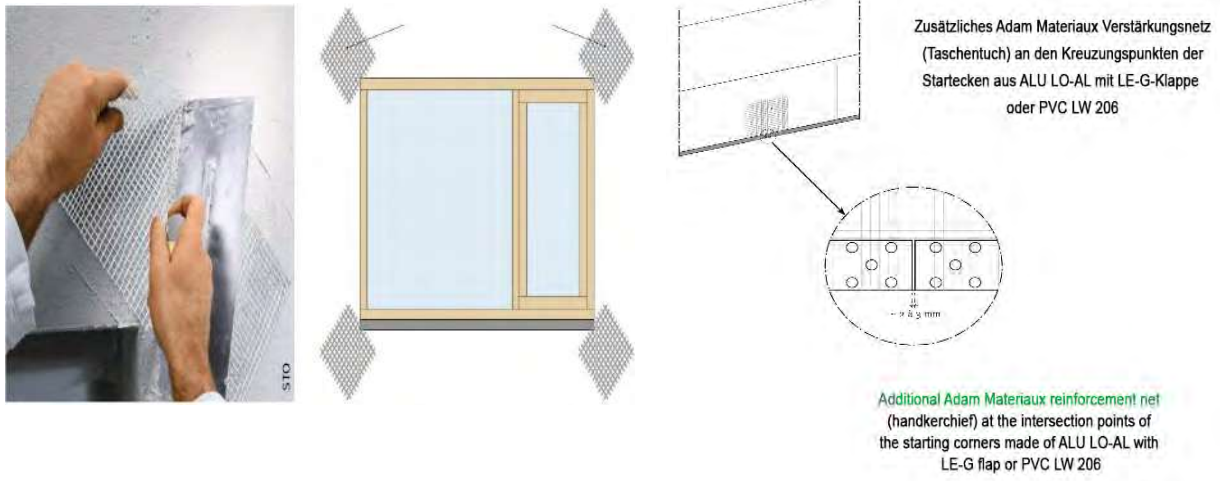

### Installation of an Illmod 600 compression joint.

As a reminder, it is mandatory to place a Illmod TP600 compression seal:

- Between the Adam Matériaux EPS HD insulation and **the aluminum or PVC starting compound.**
- Between the Adam EPS HD insulation and the aluminum or PVC starting compound **for flat roofs, sloped roofs, and balcony and terrace connections.**
- Between the Adam Matériaux EPS and the facade around the frames before **the LS-VH06 angle on the insulating side**
- Below the window sill or by installing the **LX-LPE angle bracket.**
- On the sides of the window sill or by installing **the LX-SPP angle bracket.**
- Around the VARIQ, VARIR, UMP blocks, etc.
- Between the Adam Matériaux EPS insulation and the **upper part of the facades such as wood, concrete, PVC, etc.**
- Around any element not part of the Etics Adam Matériaux system.
- Between the Adam Matériaux EPS insulation and parts of the building that are **not to be insulated.**
- Between the Adam Matériaux EPS insulation and **the edges of roofs and wall coverings.**
- Between the Adam Materials EPS insulation and **the holes and fixings**

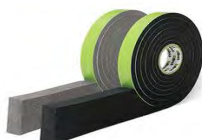

All joints between the Adam Matériaux EPS panels are well sealed with Adam Materials PUR foam.

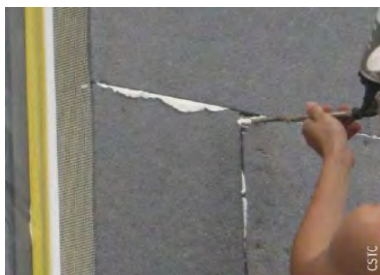

The sanding of the Adam Matériaux EPS panels was carried out with the Kubala 0343 or 0344 rasp.

## **22.2. Coating the Adam Matériaux EPS facade with Adam Matériaux gray and white glue**

- It is **mandatory** to respect the water dosage for mixing the Adam Matériaux gray or white glue, i.e. between 5 and 5.5 liters of water, mixing **for 3 to 5 minutes**, as well as the duration of its use, **i.e. 2 hours**.



Adam Matériaux **Grey Glue** well mixed and homogeneous and ready to use

- Use a **Kubala 0202 6x6mm serrated plasterer** to apply the grey or white glue to the facade with a **minimum thickness of 3mm and a maximum of 6mm per layer** of Adam Matériaux grey or white glue.-





Using Kubala 0202 6x6mm plaster

**Coating** of Adam Materiaux EPS before laying the Adam Materiaux reinforcement net



Installation of the Adam Matériaux reinforcement net with a minimum of 10cm between each strip of net



**Crushing the Adam Materiaux reinforcement net** into the Adam Materiaux gray or white glue



Use the **kubala plaster 0401 or 0534 or 0250 and 0413** to **crush the Adam Matériaux gray or white glue** with the **reinforcement net**



Crushing the **Adam Materiaux reinforcement net** into the Adam Materiaux gray or white glue



Smoothing the gray or white glue Adam materiaux  
Finished plastering





**Final appearance** of Adam Matériaux **grey or white glue** for plastering with the reinforcement net designs before **applying the Adam Matériaux primer and plaster**

**Additional recommendations:**

- Check that the Adam Matériaux **reinforcement mesh** is properly positioned on all insulation, **with a minimum overlap of 10 cm.**
- Apply **gray or white Adam Matériaux** adhesive to the Adam Matériaux EPS panels to **a thickness of 3 to 6 mm**, then place the Adam Matériaux reinforcement mesh in the Adam Matériaux adhesive **"wet on wet,"** embedding the Adam Matériaux reinforcement mesh in the center of the Adam Matériaux adhesive. Finally, press the Adam Matériaux adhesive **with Kubala 0401 or 0202 plaster** to create a flat surface.
- All strips of Adam Matériaux **reinforcement mesh** must **overlap by at least 10 cm**, following **the orange line on both sides of the 145-gram Adam Matériaux reinforcement mesh** (= 10% overlap).
- To **position the Adam Matériaux reinforcement net** in the right place in the outer half of the thickness of the base coat, i.e. around the middle for thin coatings and two-thirds for thicker coatings, it is recommended to apply **a second layer of Adam Matériaux gray or white coating glue within 24 hours of applying the first layer of Adam Matériaux gray or white coating glue** to use the "wet on wet" method and respecting the overlap of **at least 10cm** following **the orange line on both sides** of the Adam Matériaux 145 gram reinforcement net.

**22.3. Checking the Flatness and Drying of Adam Gray or White Glue**

**Materiaux**

When Adam Matériaux **gray or white glue** is **dry to the touch and visually**. The drying time of Adam Matériaux **gray or white glue** depends on weather conditions, with a minimum **drying time of 1 mm per day**, depending on the season.

This time can be significantly longer in winter conditions, depending on the following criteria:

- **Low temperatures**
- **High humidity**
- **Light winds**

In some cases, it is necessary to sand the Adam Matériaux grey or white glue with a scraper such as **the 45x9cm Hardy scraper** specially designed for this purpose to remove burrs of Adam Matériaux **gray or white glue** and thus improve the flatness of the facades before applying the Adam Matériaux plaster.



**Hardy scraper** 45x9cm

### **23. Application of Adam Matériaux primer, plaster and silicone paint**



Primer Adam Matériaux 15kg



Adam Matériaux 25kg silicone plaster



**Weather conditions** are **very important** for the application of Adam Matériaux primer and silicone plaster.

In fact, it is necessary to ensure a sufficient temperature:

- **Between 5 and 10°C:** Ensure there is no frost or precipitation for **the next 3 nights**, and ensure there is no frost on the facade.
- **Between 10 and 15°C:** Ensure there is no precipitation **for the next 24 hours**.
- **Above 15°C:** The Adam Matériaux primer and render will dry **within 2 hours of installation**.

This duration can be significantly longer in winter conditions depending on the following criteria:

- **Low temperatures**
- **High humidity**
- **Light winds**

## 23.1. Application of the Adam Matériaux primer

It is now mandatory **to apply the Adam Matériaux primer** on **the gray or white Adam Matériaux glue** using the **Kubala 4195 + Kubala 4112 roller** and the **Modeco MN-71-537 brush** for corners and window frames on all surfaces to be plastered:

**Application of Adam Matériaux Primer** on a facade wall with the **Kubala 4195 + Kubala 4112 roller**



Roule Kubala 4112 roller au Kubala 4112



Kubala 4195 Sleeve



**Application of Adam Matériaux Primer** on a facade wall with the **Kubala 4195 + Kubala 4112 roller**

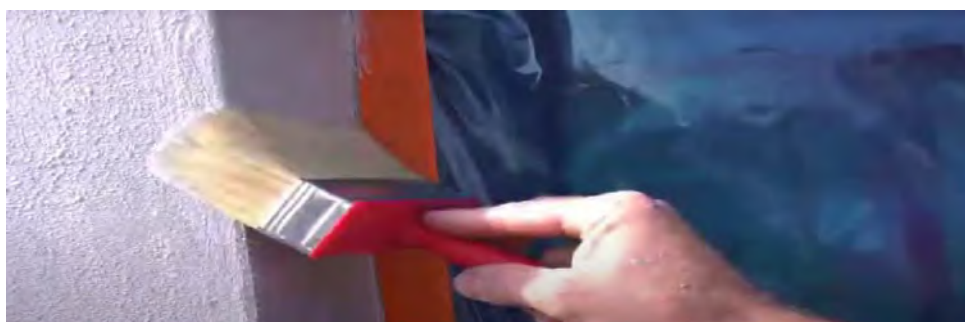

Applying **Primer Adam Matériaux** to a **window frame** with the **Modeco Brush**



**Recommendations:**

-It is **mandatory** to apply the Adam Matériaux primer after the Adam Matériaux grey or white glue has completely dried, respecting the following drying times:



**1 mm/day in summer-spring  
1 mm/2-3 days or more in winter**

-As a reminder, you must **take care to protect thresholds, cut stones, frames, etc.** using the 60cm blue protective film and the 48mm orange tape for the frames, as well as the Visqueen for floor protection.



- The Adam Matériaux primer must have **the same color reference** as the Adam Matériaux render to avoid seeing **“dots” of white primer** protruding from the color of the render applied after the Adam Matériaux render has been applied.
- **The Adam Matériaux primer is white and is also available in 274 colours found on pages 85 and 86** as well as on the website: [www.adammateriaux.be](http://www.adammateriaux.be) by typing “Adam Matériaux primer” or by purchasing our Adam Matériaux colour charts available in different formats - *see page 83.*

**Consumption of Adam Matériaux 15kg primer: Consumption = +/-40m<sup>2</sup>/bucket**

≡ between 0.35 to 0.4kg/m<sup>2</sup> depending on the surface

## **23.2. Installation of Adam Matériaux Rendering**



Adam Matériaux plasters



Plasterwork with Kubala 0401 and 0473



Applying plaster with Kubala 0300

As with the application of the primer, **weather conditions** are **very important for the application of Adam Matériaux silicone plaster**.

As already described above, it is mandatory to apply the Adam Matériaux silicone render **between 5 and 25°C** and ensure that in the following **48 hours** there is no excessive exposure **to sunlight, heavy rain, excessive humidity, or the presence of frost or ice on the facade**.

**The installation of tarpaulins** and therefore the complete assembly of the scaffolding of the facades to be rendered, can therefore ensure effective protection against wind, rain, cold winds, heat and sun (without providing a total guarantee) and thus avoid problems with color, rework, etc. in the Adam Matériaux silicone render.

After **a minimum of 6 hours depending on weather conditions** and as soon as possible to prevent the Adam Matériaux primer from getting dirty in the meantime, you must apply the Adam Matériaux silicone plaster **over the Adam Matériaux primer** previously placed.

**Apply the Adam Matériaux render by “pulling” it over** the Adam Matériaux **primer** using a **Kubala 0401 + Kubala 0473** steel trowel and float the render directly (gritting or structuring the render) with a **Kubala 0300** float for facades and **the Kubala 0380** float for corners and window frames on all surfaces to be rendered:



Truelle  
acier

**Kubala 0401 + 0473 for glue**



**Kubala 0300 for facade rendering**



**Kubala 0380 for corner  
and recess rendering**

-It is very important to work with suitable tools

**Recommandations:**

- It is mandatory to mechanically mix the buckets of Adam Matériaux silicone render on the morning of installation, visually checking the color of each bucket of Adam Matériaux render after mixing.
- For reasons of warranty and uniformity of color, it is mandatory to use buckets of Adam Matériaux silicone render from a batch of the same order for the same project by ordering +/- 5% more Adam Matériaux silicone render, so as not to run out during the installation day and thus avoid "rework" in the render.
- The addition of additives, other brands of plaster, water to Adam Matériaux plaster is not recommended and not necessary and voids all warranties;
- It is recommended to apply the Adam Matériaux plaster on the same day, wet on wet technique, without stopping to avoid creating "bonds" with sufficient qualified personnel depending on the surfaces to be plastered.
- Adam Matériaux silicone plaster is white in color and is also available in 274 colors found on pages 85 and 86 as well as on the website: [www.adammateriaux.be](http://www.adammateriaux.be) by typing "Adam Matériaux plaster" or by purchasing our Adam Matériaux color charts available in different formats:



Small Adam Matériaux Color Chart



Large Adam Matériaux Color Chart



Giant Adam Matériaux Color Chart

Consumption of Adam Materials Render 25kg: **2 à 2,5kg/m<sup>2</sup> = 8 à 10m<sup>2</sup>**

The consumption per m<sup>2</sup> of Adam Matériaux silicone plaster varies according to:

- The number of **square meters of frames** compared to the number of **square meters to be plastered**.
- **Losses due to the installer** of the Adam Matériaux silicone plaster.
- In fact, an **experienced** worker will cause almost **no plaster loss during installation**.
- Whereas an inexperienced worker will cause **significant plaster loss during installation**.

These 2 elements must be taken into account when ordering your buckets of plaster from Adam Matériaux

### **23.3. Application of Adam Matériaux silicone paint**

-If **differences in shades or troweling** of the Adam Matériaux render due to the application of the render, wind, rain, excessive sunlight when applying the buckets of render from different orders, etc. are observed after the Adam Matériaux render **has completely dried**, it is recommended to apply **2 coats of Adam Matériaux silicone paint** to all the facades if the Adam Matériaux render has **different shades or if the rain**, wind or sun have caused a certain difference in shade or troweling across all the facades.-



**Consumption in 2 layers = 33 to 50m<sup>2</sup>/10 litre bucket** depending on the porosity of the surface to be painted = 200 – 300 ml/m<sup>2</sup> (= 0.2 to 0.3 liters/m<sup>2</sup>)

- **Repainting with Adam Matériaux silicone paint will not be able to "save" the facades if the defects in the rendering work performed are such that there are significant differences in the flatness of the facades, or if heavy rain has occurred during or after the Adam Matériaux rendering. In such cases, a personalized study by an experienced contractor or expert will be necessary.**

- **Adam Matériaux silicone paint is white and is also available in 274 colors, which can be found on pages 85 and 86 and on the website: [www.adammateriaux.be](http://www.adammateriaux.be) by searching "Adam Matériaux silicone paint" or by purchasing our Adam Matériaux color charts, which are available in various formats.**

**24. Adam Matériaux primers, plasters and paints  
 are available in 274 colors**



**274 ADAM MATERIAUX COLOURS FOR  
 YOUR RENDERS, PRIMERS AND PAINTS**





**274 ADAM MATERIAUX COLOURS FOR  
YOUR RENDERS, PRIMERS AND PAINTS**

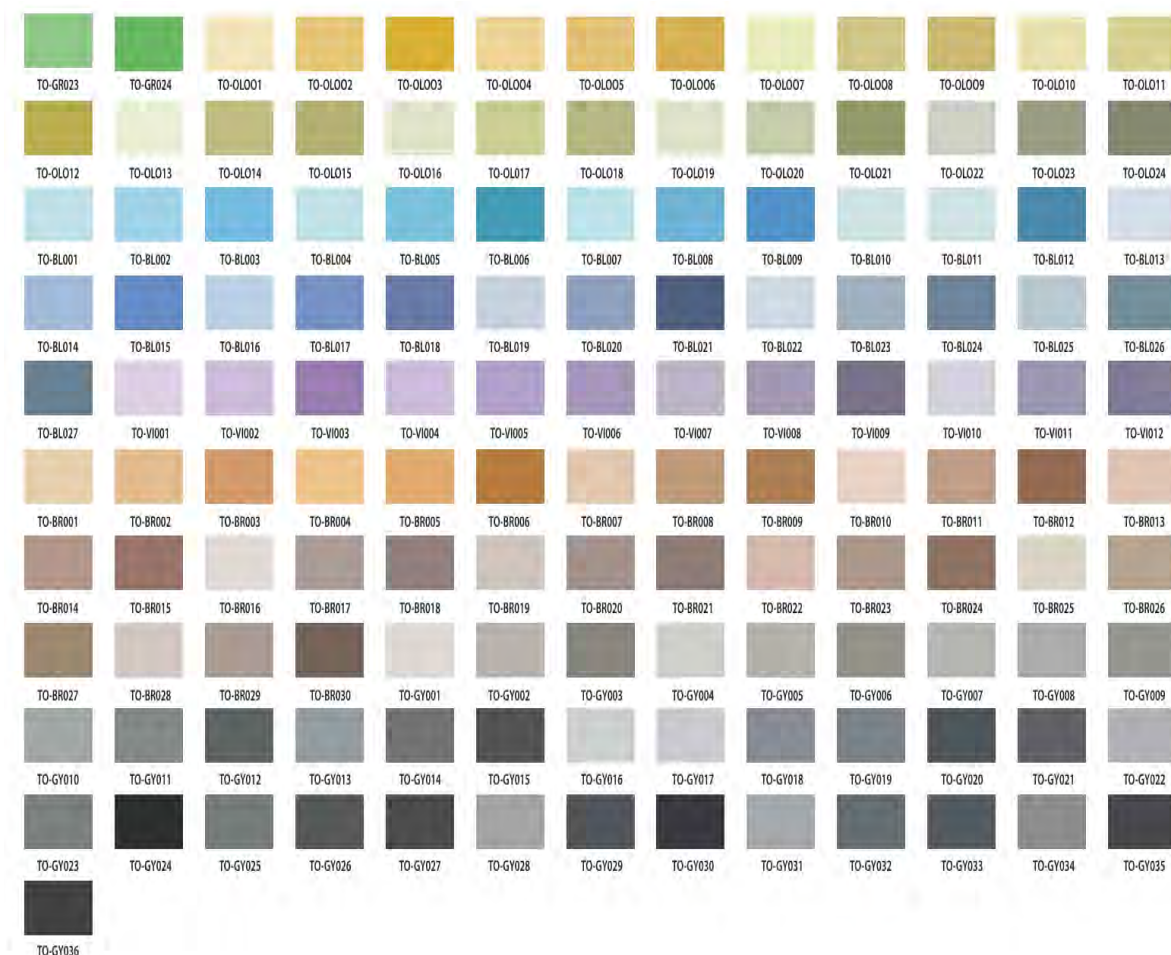

**25. Installation of the base in blue stone or with  
Adam Matériaux structured base plaster at the  
bottom of the facades**

Now that the Adam Matériaux plaster has been applied to the facades and the scaffolding has been dismantled, the base of the facades must be finished.

The Adam Matériaux basement finish will be made of an impact-resistant material such as **bluestone basement or Adam Matériaux basement render.**

### **25.1. Installation of the blue stone facade base**

- The bluestone basement tiles are fixed mechanically or **with a two-component adhesive** that prevents any moisture present in the facade from penetrating through the basement, which can cause rings on the bluestone!
- **It is also not recommended to glue the blue stone base with tile adhesive** which can also cause humidity rings on the blue stones:



Bonding of **the blue base stones** with **a 2-component silicone**:



**Blue basement stones** with **a minimum 2cm setback** from the insulated facade.

## **25.2. Laying the base with Adam “M” plaster Matériaux for base**

Finishing the Adam Matériaux basement **with Adam Matériaux silicone** render is not excluded, but it is not recommended due to **the high exposure to shocks and humidity** of the basement. If you opt for the installation of the Adam Matériaux basement render color, you must choose one of the **56 Adam Matériaux structured basement render colors**

**The marking of the separation** between the structured basement rendering system and the Adam Matériaux silicone rendering of the facade will be carried out either with **the PVC starting complex or with the ALU starting complex**

This separation will also allow easier and more localized **maintenance and repair** of parts of the basement without touching the Adam Facade Matériaux silicone-acrylic render



Kubala 0401 + 0473 for glue



Kubala 0300 for Kubala facade plaster



0380 for plastering corners and battens



Installation of Adam Matériaux basement plastering with **Kubala plasterers**



Installation of “M” Adam Matériaux base plaster with a minimum 2cm sub-base shrinkage

The consumption of Adam materials basement plaster is 4.5kg/m<sup>2</sup> = 4.5 to 6.5m<sup>2</sup> per 25kg bucket

**26. 56 colors of Adam Matériaux structured baseboard plaster are available**



**56 COLORS OF ADAM MATERIAUX SUBBASE RESISTANT TO IMPACT AND HUMIDITY TO PLACE IN THE SUBBASE OF YOUR INSULATING FACADES ADAM MATERIAUX**



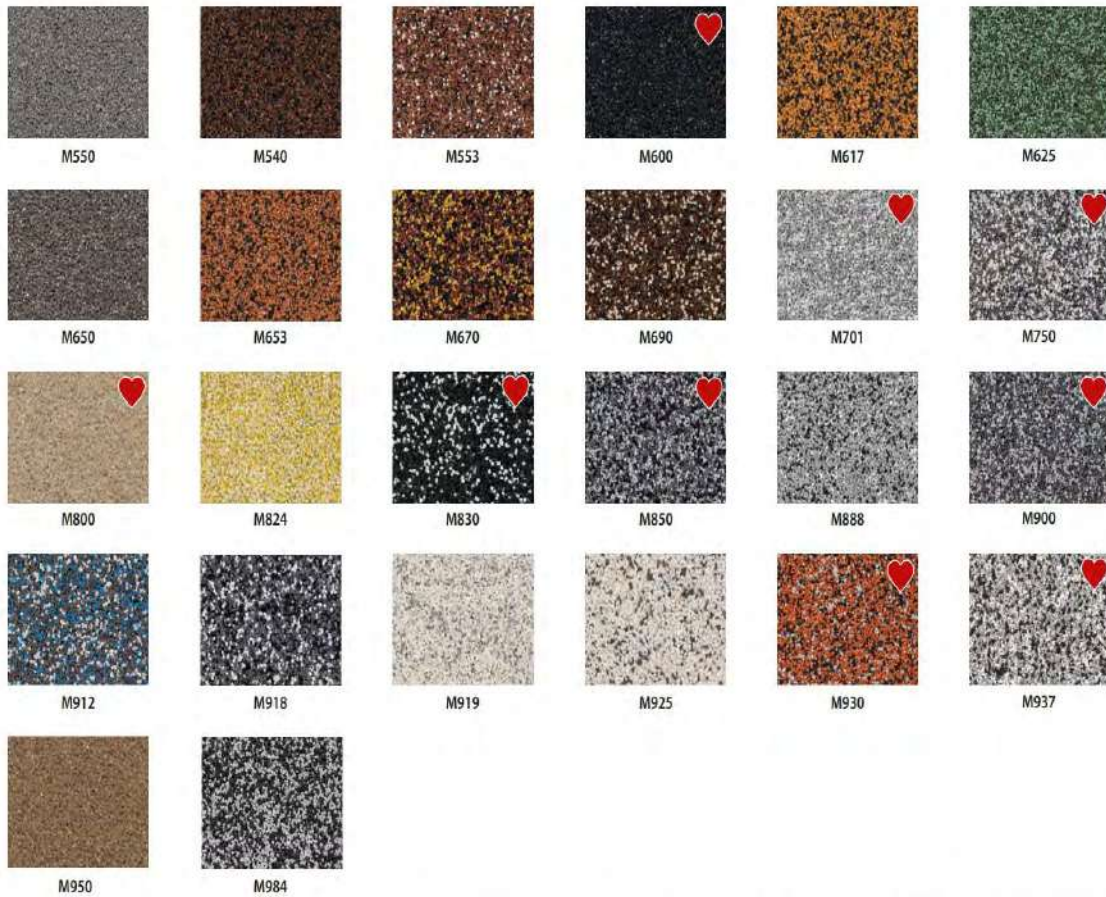

Adam materiaux 080018089 contact@adammateriaux.be Rue de l'Europe 14 - 4280 Hannut

## 27. End of facade and plastering work Adam Matériaux



It is necessary **to plan for the removal of chassis protections** such as **the blue plastic and the orange tape**.

It is also necessary to plan to clean the frames with **cleaning spirit** using a cloth.



After cleaning the frames, **the "stick"** must be removed from the LS-VH 06 6mm angle iron and if all the work has been carried out correctly, **no more silicone joint** must be placed between the **LS-VH 06 angle iron and the frame**.

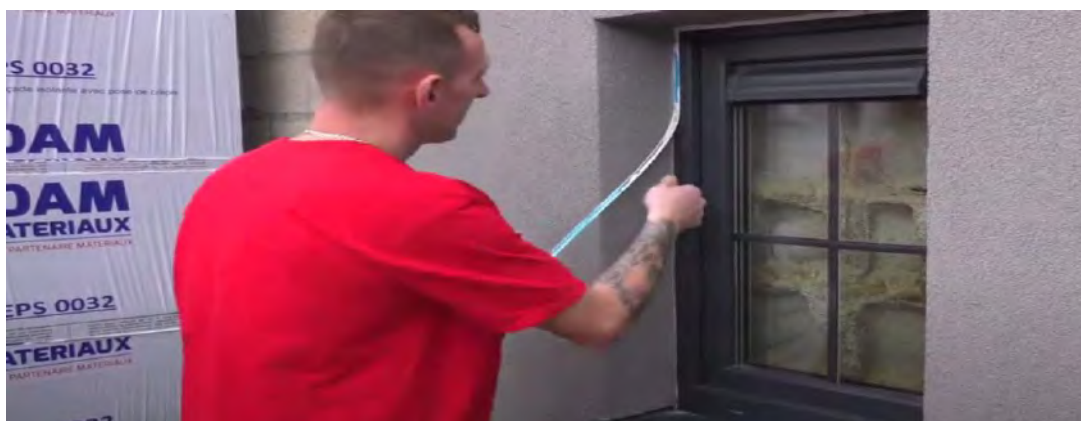

## **28. Development of the surroundings of the isolated facades Adam Matériaux**

It is recommended to create **a gravel area at least 30 cm wide around the building's insulated** facades. This area limits **the risk of splashing** onto the facade and promotes surface water drainage, while also avoiding the proximity of vegetation and **the risk of damage from gardening**.

Note that, as a general rule, the facade specialist is **only responsible for insulating the above-ground** walls in the Adam Matériaux facade and rendering system, **but also, sometimes, for insulating and finishing the building's foundations, which are not part of the Etics Adam Matériaux facade and rendering system**.



Source: Page 49 of NIT 257 from Buildwse

## **29. Traceability Adam Materiaux of the products implemented**

On each Adam Materiaux product there is a **badge** with a **serial number** which also includes the manufacturing date of the Adam Materials products.

To ensure perfect **traceability** of each Adam Matériaux product used on site, the customer **must note** (and/or take photos of) the serial number and/or keep a bag, packaging or bucket of each Adam Matériaux product used on said site.

Thus, for all requests and/or questions relating to each project, Adam Matériaux will be able, if necessary, to easily go back up the production chain and find a solution to the request and/or question from the customer if the above measures have been carried out by the customer.

This **badge** is generally found near the **barcode of each Adam Materiaux product.**

Here are some examples of badges stuck on Adam Matériaux facade and rendering products:

**Adam Materiaux White Glue Badge**

**Adam Materiaux Gray Glue Badge**

**Adam Materiaux White Primer Badge**

**Adam Materiaux Graphite EPS 032 Badge**

**Adam Materiaux White Render Badge**

**Adam Materiaux Base Render Badge in M984 color**



### **30. Maintenance and pathologies of the Etics system of Adam Matériaux facades and plasters**

-- The client must ensure **the maintenance of Adam Matériaux render facades** in order to preserve their appearance and durability. Adam Matériaux render must, therefore, be inspected regularly (at least once a year) and, if necessary, treated in consultation with a specialized firm. The frequency of maintenance of Adam Matériaux render depends to a large extent on the environment of the structure (trees, vegetation, pollution due to roads, etc.), its exposure (humidity, facades exposed to rain, the exposure of the facade to the east and north) as well as the care taken in the design and execution of the details. If necessary, **it is advisable to carry out a thorough renovation every ten years.**

-- The contractor **cannot be held responsible for the appearance of moss, algae and pollutants** on the Adam Matériaux plaster if **the Etics Adam Matériaux system has been applied in accordance with the details described in this technical note.**

<b>Object</b>	<b>Items to check</b>	<b>Actions to take (in consultation with a specialist firm)</b>	<b>Frequency of interventions</b>
<b>Moss and algae</b>	Has there been any evidence of moss and/or algae growth?	<ul style="list-style-type: none"> <li>• Dry brushing</li> </ul>	When necessary
<b>Air pollutants</b>	Are there any pollutant or dirt deposits?	<ul style="list-style-type: none"> <li>• Water cleaning, using a fungicide</li> <li>• Water-repellent treatment and/or anti-moss and algacide treatment</li> </ul>	When necessary
<b>Color variations</b>	Were there any visible color differences?	<ul style="list-style-type: none"> <li>• Application of a coat of Adam Matériaux silicone paint, possibly over a new suitable finish</li> </ul>	Every ten years  (the time may be longer depending on the type of plaster and the environment in which it is located)
<b>Damage</b>	Are there any cracks (> 0.2 mm), blisters or mechanical damage?	Any damage will be repaired as quickly as possible by a professional.	When necessary

Source: Page 139 of Buildwise's NIT 257

### Recommandations:

- When cleaning your rendered facades with water, use a maximum **pressure of 80 bars**, working at a **maximum distance of 1 meter** from the facade to be cleaned.
- When cleaning **your rendered facades** with water, preferably use **a hot water high-pressure cleaner**.
- When painting your rendered facades **with Adam Matériaux silicone paint**, protect your frames, thresholds, floors, etc. **to avoid soiling these elements**.

### 30.1. Cleaner and algae treatment for Adam Matériaux plastered facades (Fungicide)

Adam Matériaux offers various cleaning products to apply to Adam Matériaux plaster, such as **"Net'Toit Façade NETTOYANT."**

Moss can appear more quickly on facades exposed to pollution and vegetation.

Moss will also appear more quickly on **so-called "cold"** facades, i.e. facades **exposed to the east and north** because the sun only stays there for a **very short time** and the humidity therefore tends not to dry out, which causes moss, **as is the case for all other facades made of bricks, blocks, wooden cladding, etc.**

- As with brick and block facades, it may sometimes be necessary after several years to clean Adam Matériaux rendered facades using **a 60 bar hot water cleaner at a distance of 1 meter** from the facade and/or to apply a fungicide. After this cleaning, apply Adam Matériaux silicone paint depending on the green environment, unfavorable orientation, pollutants, dirt, etc., without the contractor being able to prejudge this before the work begins. Etics Adam Matériaux

- No guarantee on the appearance of moss and/or algae can be given by Adam Matériaux or by the contractor since this is maintenance work.

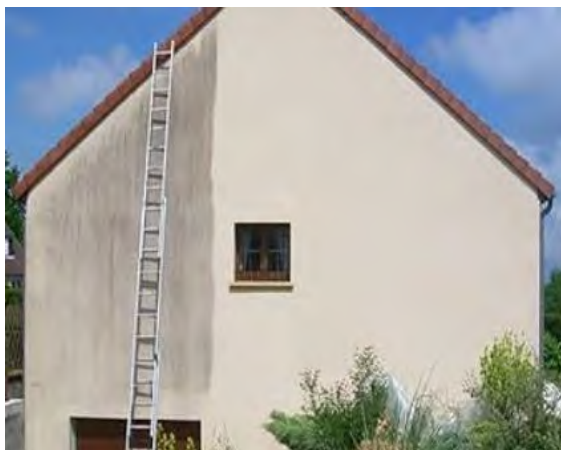

### **Recommandations:**

- When using **fungicide** to clean your facades, protect **your frames, thresholds, floors**, etc. before applying the fungicide to avoid **stains** on these elements due to the fungicide.
- When cleaning your facades with water after applying the fungicide, use a maximum **pressure of 80 bars**, working no closer **than 1 meter** from the facade to be cleaned, preferably using a **hot water** high-pressure cleaner.

## **31. Finished appearance and tolerances of Adam Matériaux facade and plastering work**

Adam Matériaux render has **a smooth, even appearance, plastered and troweled**.

The render has no surface dusting, cracks, scuffs, holes, streaks, or visible render overlays or joints.

**Check local flatness:** Take a 20cm-long level and apply it to the render in all directions. There must be **no deviation greater than 1mm**.

**Check general flatness:** Take a 200cm-long level and apply it to the render in all directions. There must be **no deviation greater than 5mm**.

**Check vertical flatness:** Take a 150cm-long level and apply it to the render in all directions. There must be **no deviation greater than 4mm**.

Use a Kubala 1331, 1337 and 1338 level



- **The control of the color, uniformity and roughness** of the Adam Matériaux plaster must be carried out after **the plaster has completely dried**, 3 meters from the facades, under natural light.
- Cracks of **less than 1mm** visible in the Adam Matériaux plaster **cannot be the subject of a claim** as long as they do not affect the technical and aesthetic quality of the facades.
- **If rain passes through the cracks**, it is considered **a technical fault** and repair work must be carried out as quickly as possible.