

catnic[®]

International Product Catalogue

2019



Contents

Introduction

Technically Superior Products	4
Help when you need it	5

Steel Lintels

Features of Catnic lintels	6
Installation in minutes	9

Lintels

Channel lintels	10
Internal wall lintels	11
Internal partition lintels	12
Lintel brackets	12
Cavity wall lintels	13

Plaster Beads

How to install Catnic plaster beads	14
Galvanised Beads	16
Galvanised beads with PVC nose	20
Stainless steel beads	21

PVCu Beads

Features of PVCu beads	23
PVCu Beads	24

External Wall Insulation

External wall insulation	26
Duo-base base profiles	31

Metal Lath

Diamond lath	32
Rib lath	33
Coil mesh	33
Mesh Arch formers	34
Mesh Arch former installation	35

Secure Mesh™

Securamesh™	36
Securamesh™ applications	39

Wall Accessories

Wall Connectors	40
Wall Ties	41
Dovetail slots	44
Head Restraints fixing	45
Bed Joint reinforcement	46
Frame cramps & movement ties	47

Technical Specification Clauses

Technical specification clauses	48
---------------------------------	----



Build it better with Catnic

Acknowledged for our excellence of service and conformance to the highest quality Standards for over 50 years, our products have been installed successfully in municipal buildings and domestic properties in over 30 countries worldwide.

Building on our strength in the steel lintels market, Catnic supply a comprehensive range of branded building components, expanded metal and plasterers' profiles which are manufactured to the same industry-leading high standard.

Selecting the Catnic brand assures that the products you have chosen are of superior quality and are fully supported by our extensive distributor network.

If you need details of your local distributor, or if you require any further information please contact.

International Sales Department

Catnic
Pontypandy Estate,
Caerphilly,
United Kingdom
CF83 3GL
Tel +44 (0) 29 2033 7900
Fax +44 (0) 29 2088 0855
www.catnic.com

Technically Superior Products

Our rigid adherence to quality control and compliance is your guarantee of technical superiority.

Quality

Catnic are committed to quality control and are a BSI registered company with quality management systems in accordance with BS EN ISO 9001: 2008.



BS EN ISO 9001 : 2008
FM 14913



BS EN ISO 14001 : 2004
EMS 555046

Material Specification

Catnic's Standard lintels are manufactured from high quality grade galvanised steel to BS EN 10346:2009 DX51D & Z275, with a black coloured polyester resin finish.

Thermal Performance / Insulation

All Catnic lintels for traditional external cavity walls are supplied fully insulated. Insulation extends continuously along the full length of the lintel, leaving no potential thermal bridges and cannot be dislodged.

Structural Performance

The structural data published in the loading tables included in this technical guide, are achieved in accordance with the requirements of BS EN 845-2 : 2013.

Independent Testing

Extensive testing was undertaken at the following test houses:

- The University of Wales, School of Engineering
- The University of South Wales, Commercial Services Centre for Engineering, Research and Environmental Applications (CEREA)
- Ceram Building Technology, Stoke-on-Trent

Fire Testing

Catnic lintels have been independently tested in accordance with the relevant parts of BS 476, Methods of Determination of the Fire Resistance of Loadbearing Elements of Construction.

Environment & Sustainability

Catnic has been certified to BES 6001 so you can rest assured that you are specifying/using a sustainable product and can maximise the potential for obtaining credits under the Responsible Sourcing of Materials sections of BREEAM, the Code for Sustainable Homes and CEEQUAL. Certification of all our steel construction products to BES 6001 provides independent verification of our corporate responsibility, including the way we drive sustainability considerations up the supply chain to the point of raw material extraction. It delivers a method for us to benchmark and show that we are continuously improving our sustainability credentials.



Customer Support

Fully committed to first class service support, providing the building industry with new and improved products, borne from investment in design and manufacturing technologies.

Full service support for customers

Catnic has been at the forefront of lintel design for over 50 years. Our reputation for exceptional quality and technical expertise has ensured customers satisfaction and loyalty in the products and services that we offer.

Catnic's team:

- Are professional and experienced
- Are extensively trained
- Have comprehensive product and industry knowledge
- Have a committed parent company - Tata Steel

Regulatory authorities approval Catnic's excellence is internationally recognised

Catnic lintels have gained the approval of the regulatory authorities both in the domestic and international markets. Such wide-spread comprehensive approval is an assurance to designers, specifiers and builders of the reliability and state-of-the-art quality of the Catnic range.

Catnic lintels are designed, manufactured and tested in accordance with BS EN 845-2:2003



BS EN 845-2 : 2013
KM 07234

BSI Kitemark

Catnic steel lintels have been awarded the BSI Kitemark license number KM07234.



91/2638

BBA Certification

Catnic steel lintels are certified by the British Board of Agrément under certificate number 91/2638.

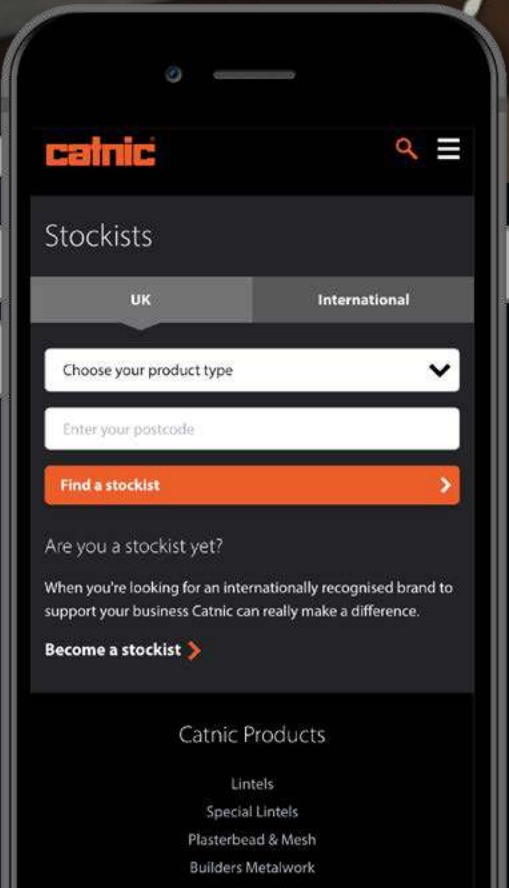

Find your local
supplier, with our
online international
stockist search

catnic.com



Features of Catnic Lintels

Catnic lintels offer many benefits to specifiers and builders through a combination of their design and corrosion protection. These features ensure that Catnic lintels are widely used and respected, throughout the building industry.



Steel



Galvanised Steel



Duplex coating



Plaster key

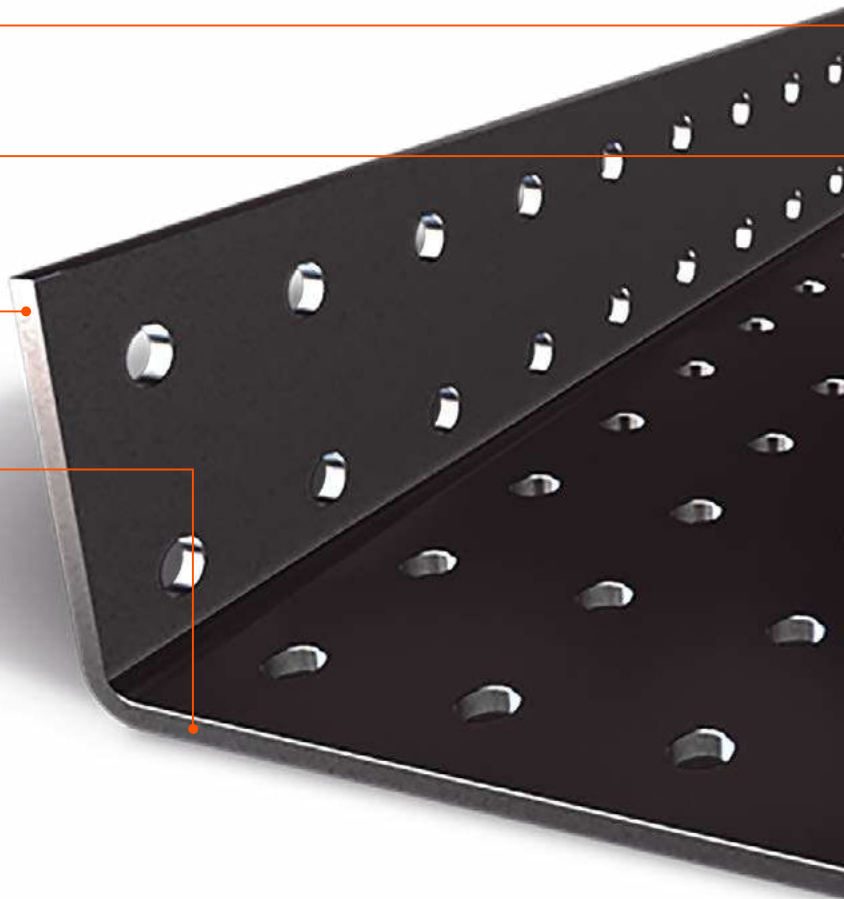



Integral Plaster Key

Many Catnic lintels come complete with an integral plaster key that avoid the hazards of working with a mesh key. In addition the unique design of the perforated base plates on CG, TS, CH, TH, CX, TX lintels minimise cold bridging without affecting the structural performance.



Continuous Insulation

Many Catnic lintels are supplied with CFC and HCFC free insulation maximising their thermal efficiency and compliance with Part L.

The insulation is accurately shaped to optimise the thermal performance extending continuously along the full length of the lintel and cannot be dislodged, leaving no potential 'cold spots'.



BS EN 845-2 : 2013
KM 07234



Duplex Corrosion Protection System

Initially, Catnic standard lintels are manufactured from hot-dipped galvanised steel to BS EN 10346: 2009 plus coating type Z275.

A coating of thermal setting polyester powder is then applied by an electrostatic process, further protecting the lintel. High temperature curing then produces a tough durable surface highly resistant to impact, abrasion and damage during rough on-site handling. This double method of protection gives Catnic lintels inherent benefits over those offered by other manufacturers using the more traditional pre- or post-galvanised steel techniques. The protection system complies fully with the chemical and physical test requirements outlined in table 2 of BS 5977: PART 2: 1983 and table C.1 of BS EN 845-2: 2003 for lintels effectively having their own built-in DPC.

Both of these processes rely on just a simple coating of zinc to provide cathodic protection. The zinc protects the steel, but is itself liable to rust with aqueous alkaline solutions leaching from the building fabric and therefore corrode. The famous black coating makes Catnic lintels instantly recognisable and provides an effective barrier against moisture or chemical attack leached from the mortar and masonry.



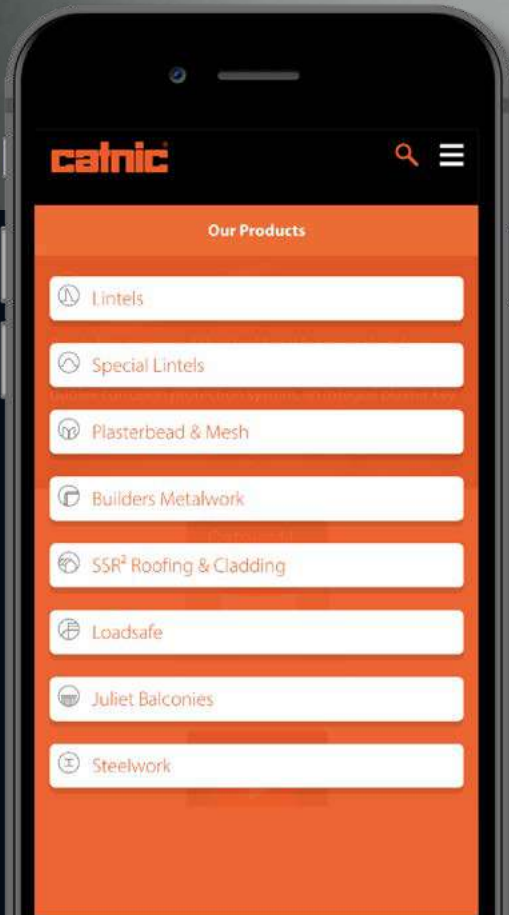

Our range of products
is growing, view the
full selection online

catnic.com

catnic[®]

Installation in Minutes

Comparison of installation times with a Catnic lintel and a conventional concrete cast in-situ lintel.

Catnic lintel installation



Total installation time – 2 minutes

Concrete cast in-situ lintel installation

- 1 Vertical framework erected and secured and a horizontal level taken.
- 2 Commencement of lintel framework.
- 3 Continuation of framework.



- 4 Completion of framework.
- 5 Completion of lintel after steel reinforcement and pouring of concrete.
- 6 Wait for concrete to set.



In the time taken to install just one concrete lintel, twenty four Catnic lintels could have been installed.

Total installation time – 48 minutes

The concrete lintel must be left to cure before continuing with blockwork installation.

Channel Lintels

For Solid Walls

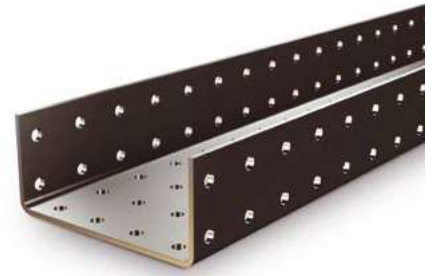
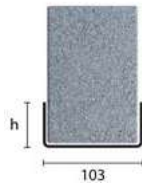

Lintel Dimension (mm)	Lintel type code	Gauge code	Sheet thickness (mm)	Weight per metre (kg)	Safe Working Load uniformly distributed (tonnes)								
					Lengths available (mm) in increments of 100 (mm)								
L	H				900-1200	1300-1500	1600-1800	1900-2100	2200-2400	2500-2700	2800-3000		
103	50	CN100	A	2.0	3.0	0.55	0.42	0.31	-	-	-	-	
			B	2.5	3.7	0.80	0.58	0.38	0.24	0.18	-	-	
			C	3.1	4.7	1.12	0.66	0.44	0.31	0.23	0.16	0.13	
	75	CN103	C	3.1	5.9	1.63	1.25	1.00	0.86	0.64	0.47	0.38	
	153	50	CN150	A	2.0	3.7	0.48	0.37	0.27	-	-	-	-
				B	2.5	4.7	0.76	0.58	0.41	0.27	0.19	-	-
C				3.1	5.9	1.22	0.79	0.52	0.37	0.28	0.19	0.14	
75		CN152	C	3.1	7.1	1.63	1.25	1.00	0.86	0.64	0.47	0.38	
203		50	CN200	A	2.0	4.4	0.62	0.48	0.35	-	-	-	-
				B	2.5	5.6	0.77	0.59	0.41	0.29	0.21	-	-
	C			3.1	7.1	1.05	0.80	0.53	0.38	0.28	0.19	0.14	
	75	CN202	C	3.1	8.5	1.63	1.25	1.00	0.86	0.64	0.47	0.37	
	253	50	CN250	A	2.0	5.4	0.62	0.48	0.35	-	-	-	-
				B	2.5	6.7	0.77	0.59	0.41	0.29	0.21	-	-
C				3.1	8.6	1.05	0.80	0.53	0.38	0.28	0.19	0.14	
75		CN252C	C	3.1	9.5	1.63	1.25	1.00	0.86	0.64	0.47	0.37	

Note: Width dimensions are 'inside of channel' dimensions.

Internal Wall Lintels



100mm Interior Solid Walls



140mm Interior

Standard Duty

Standard lengths are available in increments of 150mm at lengths up to 3000mm, 300mm at lengths from 3000mm to 4800mm (including 4575mm, but excluding 4500mm).

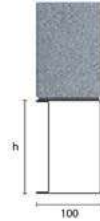

BSD100					
Standard lengths (mm)	750-2100	2250-2700	2850-3600	3900-4575	4800
SWL (kN)	19	20	29	29	27
Weight (kg/m)	6.0	7.5	12.4	15.7	15.7
Nominal height (mm)	143	143	219	219	219

Standard lengths are available in increments of 150mm at lengths up to 3000mm, 300mm at lengths from 3000mm – 4800mm (including 4575mm, but excluding 4500mm).



BSD140					
Standard lengths (mm)	750-2100	2250-2700	2850-3600	3900-4575	4800
SWL (kN)	19	20	29	29	27
Weight (kg/m)	6.9	8.7	13.1	16.2	16.2
Nominal height (mm)	143	143	219	219	219

Heavy Duty



BHD100					
Standard lengths (mm)	750-1500	1650-2100	2250-2700	2850-3600	3900-4800
SWL (kN)	29	39	39	51	51
Weight (kg/m)	7.5	9.4	12.4	15.7	18.8
Nominal height (mm)	143	143	219	219	295



BHD140					
Standard lengths (mm)	750-1500	1650-2100	2250-2700	2850-3600	3900-4800
SWL (kN)	29	39	39	51	51
Weight (kg/m)	8.7	10.9	13.1	16.2	20.5
Nominal height (mm)	143	143	219	219	295

Extra Heavy Duty



BXD100		
Standard lengths (mm)	750-1500	1650-2700
SWL (kN)	47	59
Weight (kg/m)	9.4	15.7
Nominal height (mm)	143	219



BXD140		
Standard lengths (mm)	750-1500	1650-2700
SWL (kN)	47	59
Weight (kg/m)	10.9	16.2
Nominal height (mm)	143	219

Internal Partition Lintels

75 - 100mm Wide Internal Walls

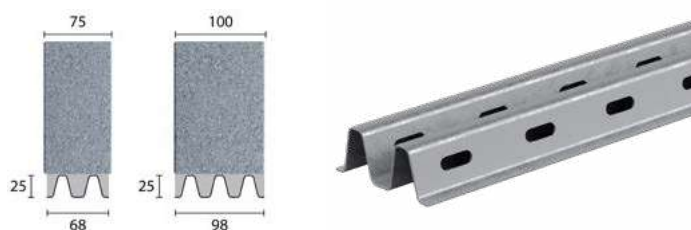

Wall width (mm)	Lintel dimension W (mm)	H (mm)	Lintel type/code	Gauge code	Steel thickness (mm)	Weight (kg per metre)	Safe Working Load (tonnes)	Lengths available (metres)
75	65	25	CN92	-	1.2	1.2	0.7	1.05 & 1.20
100	98	25	CN102	-	1.2	1.8	0.7	1.05 & 1.20

Catnic corrugated lintels **CN92** and **CN102** are designed for internal partition walls only and are manufactured from galvanised steel to BS EN 10327:2004-DX51D+Z275.

These lintels are supplied in plain galvanised steel without powder coating.

Note: When using these lintels normal building practice should be observed, in that one course of blockwork (Nominal height 200mm) should be laid on the lintel and the mortar allowed to harden for at least 24 hours before additional loads are applied.

Lintel Brackets

External Application

Code Reference	Suitable for lintels	Maximum load tonnes/bracket			
SB 02/15P*	CN56X, CN66X	0.45	-	0.72	-
SB 02/15P/A1*	CN56X, CN66X	-	0.72	-	0.72
SB 02/19P*	CN71, CN81, CN19/14, CN19/19	0.50	-	0.88	-
SB 02/19P/A1*	CN71, CN81, CN19/14, CN19/19	-	0.88	-	0.90
SB 02/24P*	CN7, CN8	0.50	-	0.88	-
SB 02/24P/A1*	CN7, CN8	-	0.88	-	1.04
SB 02/28P*	CN11, CN12	0.50	-	0.88	-
SB 02/28P/A1*	CN11, CN12	-	0.88	-	1.15
Metal expansion anchors quantity - diameter (mm)		2 No. M8	2 No. M10	4 No. M8	4 No. M10



Perforated



Unperforated

Internal Application

Code Reference	Suitable for lintels	Maximum load tonnes/bracket			
SB 01	CN5X, CN6X, CN100, CN1022, CN103	0.50	-	0.80	-
SB 01/A1	CN5X, CN6X, CN100, CN1022, CN103	-	0.88	-	0.90
SB 03	CN150, CN152	0.50	-	0.80	-
SB 03/A1	CN150, CN152	-	0.88	-	0.90
SB 08	CN200, CN202	0.50	-	0.77	-
Metal expansion anchors quantity - diameter (mm)		2 No. M8	2 No. M10	4 No. M8	4 No. M10



* Unperforated brackets can be supplied on request, simply delete "P" from code reference.

Cavity Wall Lintels

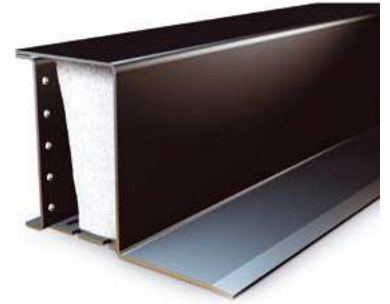

Classic Box Lintels

For 200mm Wide Walls

Lintel dimension L (mm) H	Lintel type/ code	Gauge code	Steel thickness (mm)	Weight (kg per metre)	Safe Working Load (tonnes)	Lengths available (metres)
195 143	CN71	A	2.0 2.0 1.6	9.3	2.0	1.95, 2.25 in 150mm increments
195 219	CN81	B	2.5 2.5 2.0	15.1	3.0	3.00, 3.30, 3.60
195 219	CN81	C	3.1 3.1 2.0	18.5	3.0	3.90, 4.20

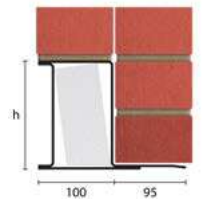

Open Back Lintels

For 90 - 105mm Cavity 100 - 115mm Inner Leaf



CG90/100							
Standard lengths (mm)	750-1500	1650-1800	1950-2100	2250-2400	2550-2700	2850-3000	3000-3600
SWL 1 : 1/3 : 1 (kN)	15	18	20	22	26	26	26
Weight (kg/m)	5.8	7.3	8.0	8.6	9.8	12.3	16.0
Nominal height (mm)	140	140	160	180	220	220	220

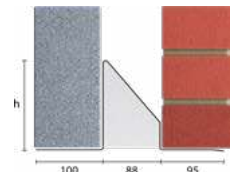

For 90 - 105mm Cavity 125 - 140mm Wide Inner Leaf

CG90/125					
Standard lengths (mm)	750-1500	1350-1800	1950-2400	2250-2700	2850-3000
SWL 1 : 1/3 : 1 (kN)	12	17	20	26	26
Weight (kg/m)	6.3	7.8	9.0	12.9	16.6
Nominal height (mm)	140	140	180	220	220

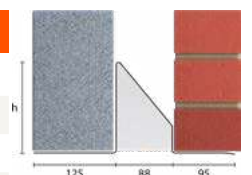

Plaster Beads

Our comprehensive range of Plaster Beads are precision engineered and simple to use. Fixing by nail or plaster dab is straightforward and fast, generating arises, edges, corners and joints that are easy to form and resistant to chipping, cracking and impact damage.

How to install a Catnic plasterer's bead

The most appropriate Catnic bead should be chosen to suit the application, required plaster depth and the desired finish of the work.

The application and installation of Catnic beads should be in accordance with BS 5492:1990 Code of Practice for internal plastering and BS 5262:1991 Code of Practice for external renderings.

Catnic beads should be fixed at a nominal 600mm spacing by embedding with dabs

of the same material used for the undercoat or corrosion resistant galvanised nails for galvanised bead and stainless steel nails for stainless steel bead.

Beads may be trimmed to length using tinman's shears across the wings and a fine toothed saw across bead noses.

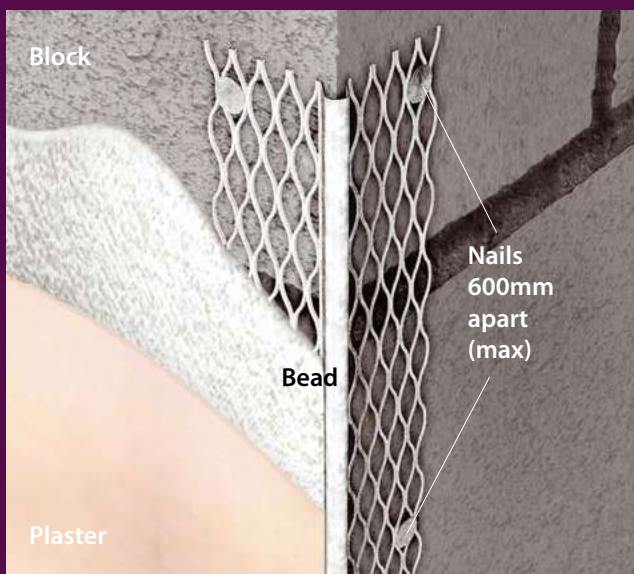
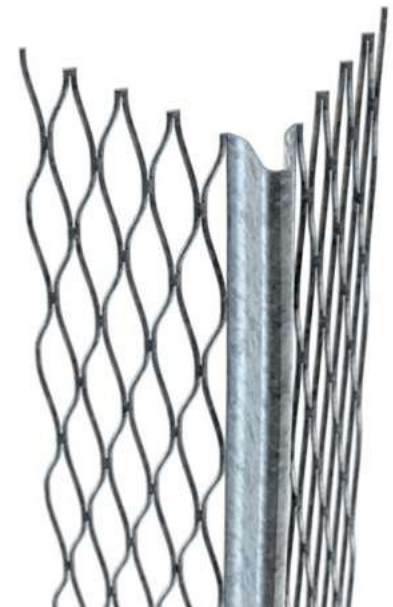

Use one of the following methods to fix Catnic angle beads and plaster stop beads:

- a) Using galvanised or stainless steel nails (compatible with bead material) complying with BS 1202: Part 1, fixed at a maximum of 600mm apart. When nailing to a solid background the line of the bead will follow the line of the background.

Plaster Beads

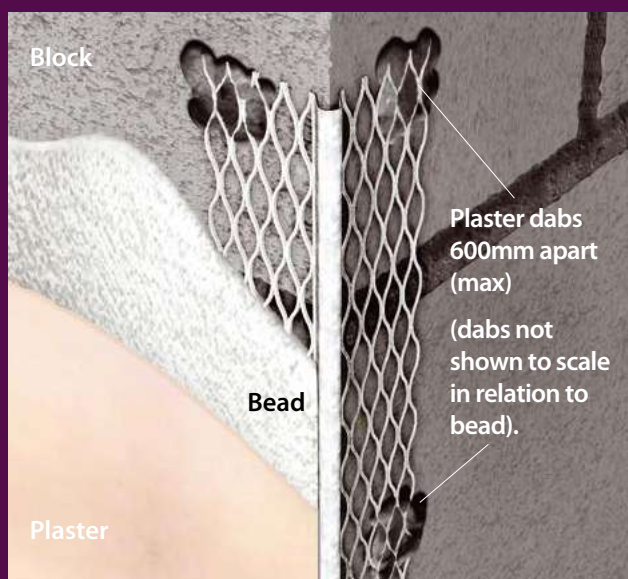

- b) Pressing the bead onto dabs of the same material as the undercoat, dabs should be applied at a maximum of 600mm apart. This method will even out minor irregularities in the line of the background, although the line of the bead will tend to generally follow the line of the background.
- c) When beads are used with metal lath backgrounds, galvanised or stainless steel tying wire may be used to secure the beads in position. Soft galvanised wire to BS 443 and soft stainless steel wire complying with BS 1554 should be used to match the bead and lath materials. All wires should be twisted tightly and the ends bent away from the finished face of the coating.

Corrosion Protection

In normal circumstances, matured plasterwork may be regarded as dry and therefore non-corrosive. Risks of corrosion in galvanised accessories only normally becomes apparent during the initial plaster drying out period, which should be kept to a minimum, and subsequently during periods of heavy condensation.

All backgrounds should be free of deleterious substances such as mould, oil and grease and be adequately prepared to accommodate the finished surface, all beading and attendant fixings at the specified depths.

The use of sand or water contaminated with soluble salts in plastering mixes should be avoided as should soluble chlorides as they are likely to increase the risk of metal corrosion. The presence of sea salts in sand used in plastering which is in contact with galvanised accessories will often cause rust staining and should therefore be avoided.

In external applications and, in conditions where heavy condensation, persistent damp or regular exposure to moisture are likely, stainless steel, PVCu or PVCu nosed products should be specified.

In general, care should be taken to ensure that metal accessories are kept dry and distortion is prevented during storage and handling. Care should also be taken to prevent mechanical damage to the galvanised coating.

Stainless steel products are for use specifically with cement based renders.

Catnic Plaster Beads are manufactured to BS EN 13658 : 2008 - Part 1 & 2. Galvanised products are manufactured with steel in accordance to BS EN 10346: 2009-DX51D+Z275.

Galvanised Beads

Angle Beads

Provides true and straight corners which are resistant to chipping and cracking giving strength and protection against everyday knocks.

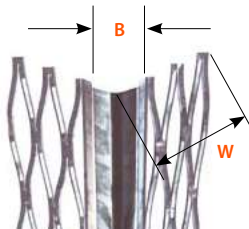

Chisel Nose Angle Bead

4000

lengths:
3.0m

Shrink film Euro packaged,
25 lengths/pack

B = 7.5mm

W = 34mm

12mm Plaster thickness

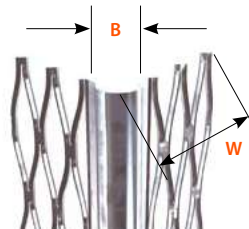

Round Nose Angle Bead

4001

lengths:
3.0m

Shrink film Euro packaged,
25 lengths/pack

B = 7.5mm

W = 34mm

12mm Plaster thickness

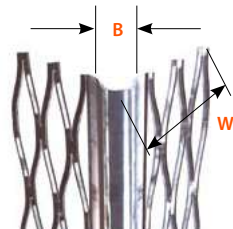

Angle Bead

AB 38

lengths:
3.0m

50 lengths/
pack

B = 5mm

W = 38mm

13mm Plaster thickness

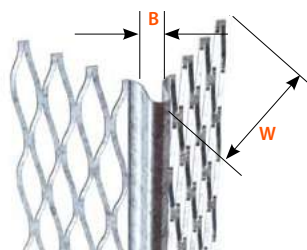

Supasave Angle Bead

SS

lengths:
2.4m, 2.7m, 3.0m

50 lengths/
pack

B = 5mm wide

W = 45mm

13mm Plaster thickness

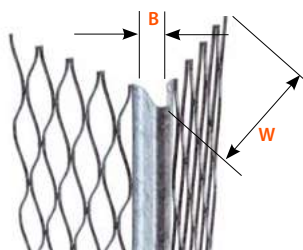

Standard Angle Bead

STD

lengths:
2.4m, 2.7m, 3.0m

50 lengths/
pack

B = 5mm wide

W = 53mm

12-19mm Plaster thickness

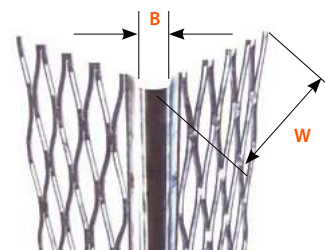

Wide Wing Angle Bead

WW 3.0

lengths:
3.0m

50 lengths/
pack

B = 5mm wide

W = 65mm

12-19mm Plaster thickness

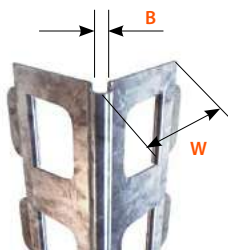

Square Hole Angle Beads - Small Nose

4004

lengths:
2.5m, 3.0m

Shrink film Euro packaged,
25 lengths/pack

B = 3mm wide

W = 30mm

7mm Plaster thickness

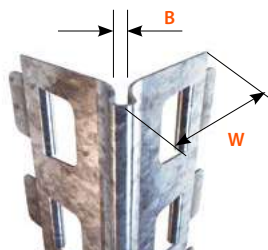

Square Hole Angle Beads - Small Nose

4005

lengths:
2.5m, 3.0m

Shrink film Euro packaged,
25 lengths/pack

B = 4mm wide

W = 40mm

10mm Plaster thickness

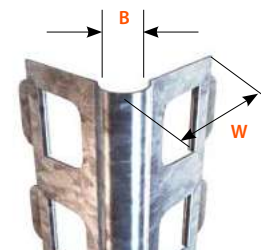

Square Hole Angle Beads - Round Nose

4006

lengths:
2.5m, 3.0m

Shrink film Euro packaged,
25 lengths/pack

B = 9.5mm wide

W = 30mm

10mm Plaster thickness

Catnic Plaster Beads are manufactured to BS EN 13658 : 2008 - Part 1 & 2.
Galvanised products are manufactured with steel in accordance to BS EN 10346:
2009-DX51D+Z275.

Galvanised Beads

Plasterstop

Provides clean, neat edges at openings or abutments onto other wall surfaces or ceiling finishes.

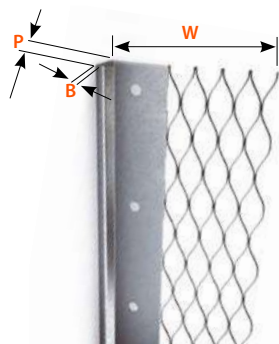

Plasterstop Bead

PS10	PS13	PS16	PS19
lengths: 3.0m, 2.7m, 2.4m	lengths: 3.0m, 2.7m, 2.4m	lengths: 3.0m, 2.7m, 2.4m	lengths: 3.0m, 2.7m, 2.4m
50 lengths/pack	50 lengths/pack	50 lengths/pack	50 lengths/pack
W = 58mm	W = 55mm	W = 60mm	W = 57mm
B = 3mm	B = 3mm	B = 3mm	B = 3mm
P = 10mm	P = 13mm	P = 16mm	P = 19mm
10mm Plaster thickness	13mm Plaster thickness	16mm Plaster thickness	19mm Plaster thickness

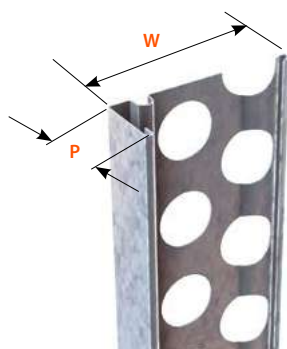

Plasterstop Punched Wing

6212	6213	6214
lengths: 2.5m, 3.0m	lengths: 2.5m, 3.0m	lengths: 2.5m, 3.0m
25 lengths/pack	25 lengths/pack	25 lengths/pack
W = 53mm width	W = 53mm width	W = 53mm width
P = 18mm	P = 12mm	P = 8mm
18mm Plaster thickness	12mm Plaster thickness	8mm Plaster thickness

Architrave

Gives a shadow line decorative effect for aesthetic purposes and creates a clean division between varying wall finishes.

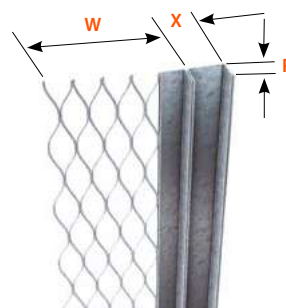

Architrave with Flange

ARC10/WF/3.0	ARC13/WF/3.0	ARC20/WF/3.0	ARC30/WF/3.0
lengths: 3.0m	lengths: 3.0m	lengths: 3.0m	lengths: 3.0m
25 lengths/pack	25 lengths/pack	25 lengths/pack	25 lengths/pack
W = 37mm	W = 37mm	W = 37mm	W = 37mm
X = 13mm	X = 13mm	X = 20mm	X = 27mm
P = 10mm	P = 13mm	P = 13mm	P = 13mm
10mm Plaster thickness	13mm Plaster thickness	13mm Plaster thickness	13mm Plaster thickness

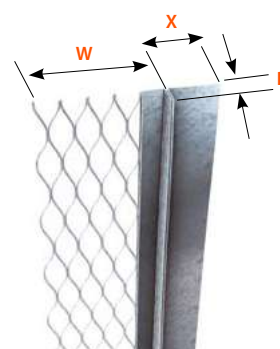

Architrave without Flange

ARC10/WO/3.0	ARC13/WO/3.0
lengths: 3.0m	lengths: 3.0m
25 lengths/pack	25 lengths/pack
W = 37mm	W = 37mm
X = 20mm	X = 20mm
P = 10mm	P = 13mm
10mm Plaster thickness	13mm Plaster thickness

Catnic Plaster Beads are manufactured to BS EN 13658 : 2008 - Part 1 & 2.
Galvanised products are manufactured with steel in accordance to BS EN 10346: 2009-DX51D+Z275.

Galvanised Beads

Drywall and Thin Coat Plaster Applications

Designed for single/thin coat plasterwork, enabling a thin coat finish of just 3mm.

Micromesh angle beads have fine mesh wings suitable for a single/thin coat of 6mm.

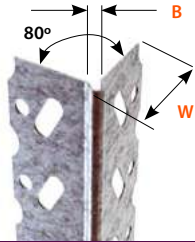

Drywall Angle Bead

DW

2.4m, 3.0m lengths

50 lengths/pack

B = 3mm

W = 25mm

6mm Plaster thickness

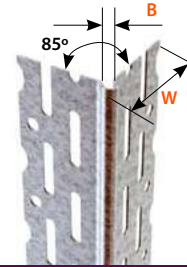

Drywall Thin Coat Bead

DWTC

2.4m, 3.0m lengths

50 lengths/pack

B = 3mm

W = 23mm

3mm Plaster thickness

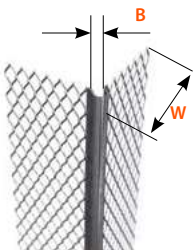

Micromesh Angle Bead

MM

2.4m, 3.0m lengths

50 lengths/pack

B = 3mm

W = 25mm

6mm Plaster thickness

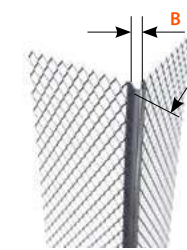

Micromesh Angle Bead Wide Wing

MMW

2.4m, 3.0m lengths

50 lengths/pack

B = 3mm

W = 30mm

6mm Plaster thickness

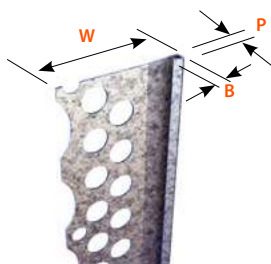

Drywall Stop Bead

DWSB3

DWSB6

3.0m lengths

3.0m lengths

50 lengths/pack

50 lengths/pack

W = 30mm

W = 30mm

B = 3mm

B = 3mm

P = 3mm

P = 6mm

3mm Plaster thickness

6mm Plaster thickness

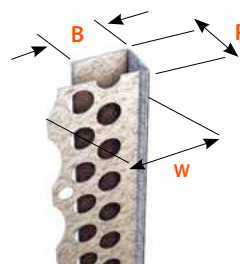

Plasterboard Edging Bead

PBEB 10

PBEB 13

PBEB 15

3.0m lengths

3.0m lengths

3.0m lengths

50 lengths/pack

50 lengths/pack

50 lengths/pack

W = 25mm

W = 25mm

W = 25mm

B = 12mm

B = 10mm

B = 9mm

P = 10mm

P = 13mm

P = 15mm

2mm Plaster thickness

2mm Plaster thickness

2mm Plaster thickness

Catnic Plaster Beads are manufactured to BS EN 13658 : 2008 - Part 1 & 2.
Galvanised products are manufactured with steel in accordance to BS EN 10346:
2009-DX51D+Z275.

Galvanised Beads

Movement Beads

Movement bead allows for movement between adjoining surfaces resulting in differential expansion and expansion within the plaster /rendered area. Allows movement of +/- 3mm. Movement Beads should be installed at no greater than 5m intervals. Movement Beads should not be used over structural movement /control joints.

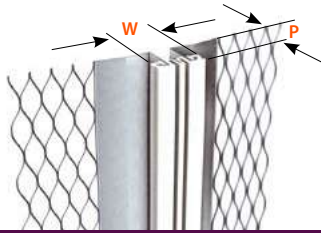

Movement Bead

MB10	MB13	MB16	MB19
Galvanised with PVCu strip	Galvanised with PVCu strip	Galvanised with PVCu strip	Galvanised with PVCu strip
3.0m lengths	3.0m lengths	3.0m lengths	3.0m lengths
10 lengths/pack	10 lengths/pack	10 lengths/pack	10 lengths/pack
W = 25mm	W = 25mm	W = 25mm	W = 25mm
P = 12mm	P = 15mm	P = 18mm	P = 21mm
12mm Plaster thickness	15mm Plaster thickness	18mm Plaster thickness	21mm Plaster thickness

Depth Gauge Beads

Provides a quick and accurate means of ensuring consistent, minimum plaster depths as plaster is simply 'ruled off' to leave the required thickness.

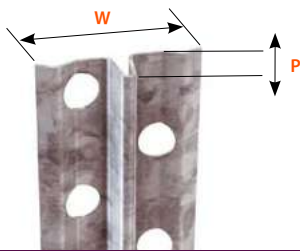

Depth Gauge Bead

4100	4101
2.5m, 3.0m lengths	2.5m, 3.0m lengths
25 lengths/pack, 25 lengths/pack, Shrink film Euro packaged	25 lengths/pack, 25 lengths/pack, Shrink film Euro packaged
W = 21mm	W = 23mm
P = 6mm	P = 10mm
6mm Plaster thickness	10mm Plaster thickness

Renderstop Beads

Renderstop beads are used to obtain a neat, bell cast lower edge to external finishes and helps to protect masonry against run-off water.



Renderstop Bead

RS3.0

Galvanised finish

3.0m lengths 50 lengths/pack

D = 45mm W = 25mm A = 120°

19mm Plaster thickness

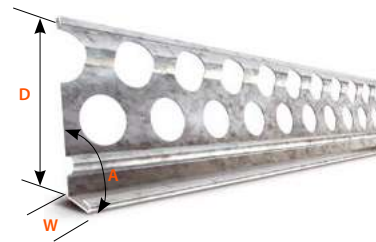

Renderstop Punched Wing

6215	6217	6219
2.5m, 3.0m lengths	2.5m, 3.0m lengths	2.5m, 3.0m lengths
25 lengths/pack	25 lengths/pack	25 lengths/pack
D = 53mm	D = 53mm	D = 53mm
W = 13mm	W = 9mm	W = 18mm
A = 110°	A = 110°	A = 110°
13mm Plaster thickness	13mm Plaster thickness	13mm Plaster thickness

Galvanised Beads with PVC Nose

Angle Beads

Provide true and straight corners which are resistant to chipping and cracking giving strength and protection against everyday knocks whilst the PVCu nose adds the advantage of a light, non-corrosive elegant solution for an aesthetic finish.

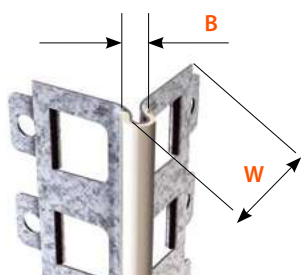

Square Holed Angle Bead

6000	6001	6050	6051
2.5m, 3.0m lengths	2.5m, 3.0m lengths	2.5m, 3.0m lengths	2.5m, 3.0m lengths
15 lengths/pack, Shrink film Euro packaged	15 lengths/pack, Shrink film Euro packaged	15 lengths/pack, Shrink film Euro packaged	15 lengths/pack, Shrink film Euro packaged
W = 30mm	W = 41mm	W = 41mm	W = 52mm
B = 7mm	B = 8mm	B = 8.5mm	B = 8.5mm
12mm Plaster thickness	19mm Plaster thickness	14mm Plaster thickness	14mm Plaster thickness

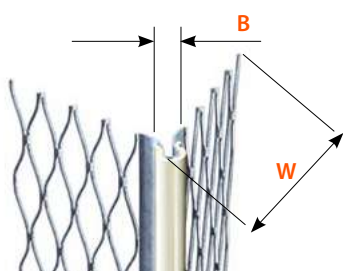

Standard Angle Bead

STD/PVC

2.7m, 3.0m lengths	50 lengths/pack Shrink film Euro packaged
B = 8mm	W = 53mm
12-19mm Plaster thickness	

Supersave Angle Bead

ABPVC13

2.7m, 3.0m lengths	50 lengths/pack Shrink film Euro packaged
B = 8mm	W = 45mm
10-13mm Plaster thickness	

Plasterstop Beads

Provide clean and straight edges whilst the PVCu nose adds the advantage of a light, non-corrosive elegant solution for an aesthetic finish with an easy to use material.

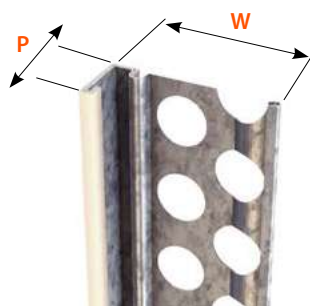

Plasterstop Bead

6222	6223	6224
2.7m, 3.0m lengths	2.7m, 3.0m lengths	2.7m, 3.0m lengths
25 lengths/pack Shrink film Euro packaged	25 lengths/pack Shrink film Euro packaged	25 lengths/pack Shrink film Euro packaged
W = 53mm	W = 53mm	W = 53mm
P = 20mm	P = 14mm	P = 10mm
20mm Plaster thickness	14mm Plaster thickness	10mm Plaster thickness

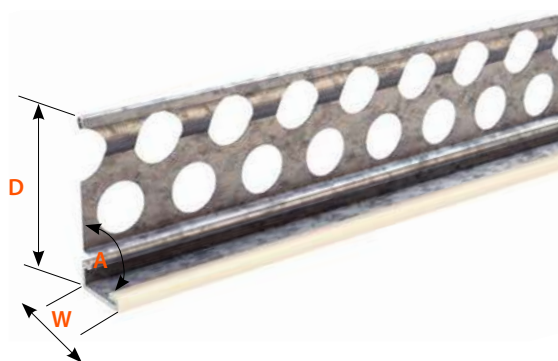

Plasterstop Bead

6225	6227	6229
2.7m, 3.0m lengths	2.7m, 3.0m lengths	2.7m, 3.0m lengths
25 lengths/pack Shrink film Euro packaged	25 lengths/pack Shrink film Euro packaged	25 lengths/pack Shrink film Euro packaged
D = 53mm	D = 53mm	D = 53mm
W = 14mm	W = 10mm	W = 20mm
A = 110°	A = 110°	A = 110°
14mm Plaster thickness	10mm Plaster thickness	20mm Plaster thickness

Stainless Steel Beads

Angle Beads

Provide true and straight corners which are resistant to chipping and cracking giving strength and protection against everyday knocks.

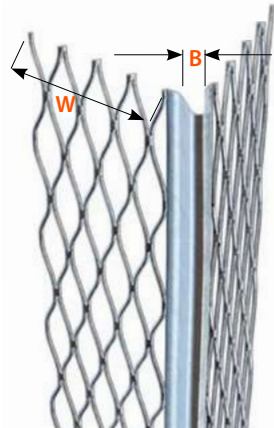

Standard Angle Bead

STD 3.0/SS

3.0m lengths

50 lengths/pack

B = 5mm

W = 53mm

12-19mm Plaster thickness

Supasave Angle Bead

SS3.0/SS

lengths: 2.4m, 2.7m, 3.0m

50 lengths/ pack

B = 5mm wide

W = 45mm

13mm Plaster thickness

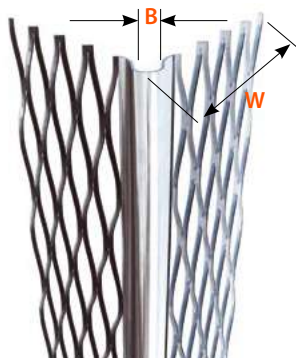

Wide Wing Angle Bead

WW 3.0/SS

3.0m lengths

50 lengths/pack

B = 5mm

W = 65mm

12-19mm Plaster thickness

Plasterstop Beads

Provide clean, neat edges at openings or abutments onto other wall surfaces or ceiling finishes.

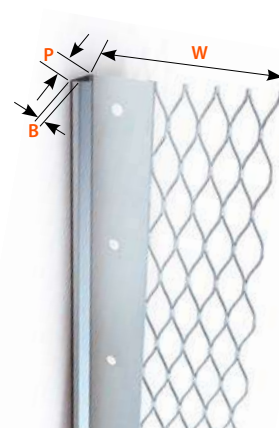

Plasterstop Bead

PS10/3.0/SS

3.0m lengths

50 lengths/pack

W = 58mm

B = 3mm

P = 10mm

10mm Plaster thickness

PS13/3.0/SS

3.0m lengths

50 lengths/pack

W = 55mm

B = 3mm

P = 13mm

13mm Plaster thickness

PS16/3.0/SS

3.0m lengths

50 lengths/pack

W = 60mm

B = 3mm

P = 16mm

16mm Plaster thickness

PS19/3.0/SS

3.0m lengths

50 lengths/pack

W = 57mm

B = 3mm

P = 19mm

19mm Plaster thickness

Quality: Manufactured from Stainless Steel to BS EN 10088-2-1.4301. All beads shown are manufactured in accordance with BS EN 13658: 2005.

Stainless Steel Beads

Architrave Bead

Provide a shadow line decorative effect for aesthetic purposes and creates a clean division between varying wall finishes eg. at wall and ceiling abutments or door and window reveals.

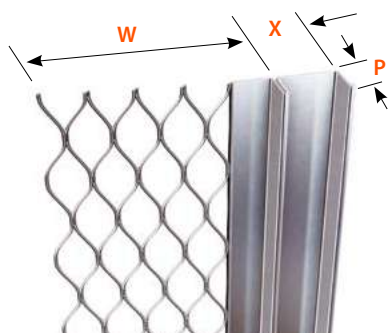

Architrave with Flange

ARC10/WF/3.0/SS	ARC13/WF/3.0/SS	ARC20/WF/3.0/SS	ARC30/WF/3.0/SS
3.0m lengths	3.0m lengths	3.0m lengths	3.0m lengths
25 lengths/pack	25 lengths/pack	25 lengths/pack	25 lengths/pack
W = 37mm	W = 37mm	W = 37mm	W = 37mm
X = 13mm	X = 13mm	X = 20mm	X = 13mm
P = 10mm	P = 13mm	P = 13mm	P = 13mm

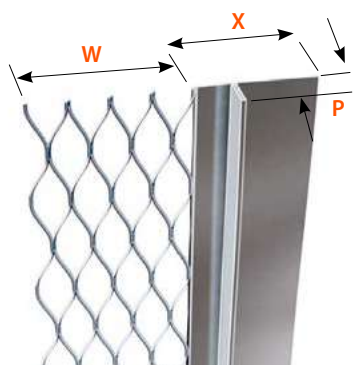

Architrave without Flange

ARC10/WO/3.0/SS	ARC13/WO/3.0/SS
3.0m lengths	3.0m lengths
25 lengths/pack	25 lengths/pack
W = 37mm	W = 37mm
X = 20mm	X = 20mm
P = 10mm	P = 13mm
10mm Plaster thickness	13mm Plaster thickness

Movement Bead

Movement bead allows for movement between adjoining surfaces resulting in differential expansion and expansion within the plaster/rendered area. Allows movement of +/- 3mm. Movement Beads should be installed at no greater than 5m intervals. Movement Beads should not be used over structural movement / control joints.



Movement Bead

MB10SS	MB13SS	MB16SS	MB19SS
3.0m lengths	3.0m lengths	3.0m lengths	3.0m lengths
10 lengths/pack	10 lengths/pack	10 lengths/pack	10 lengths/pack
W = 25mm	W = 25mm	W = 25mm	W = 25mm
P = 12mm	P = 15mm	P = 18mm	P = 21mm
12mm Plaster thickness	15mm Plaster thickness	18mm Plaster thickness	21mm Plaster thickness

Renderstop Bead

Renderstop beads are used to obtain a neat, bell cast lower edge to external finishes and helps to protect masonry against run-off water.

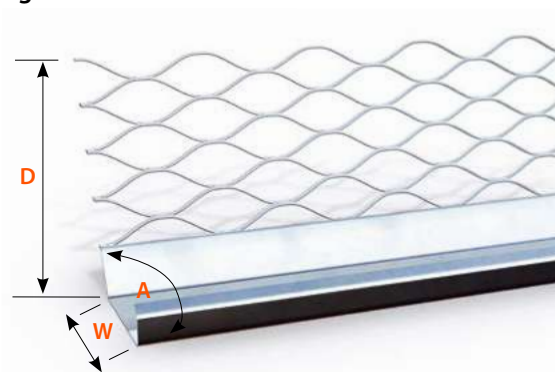

Renderstop Bead

RS3.0/SS		
3.0m lengths	50 lengths/pack	
D = 45mm	W = 25mm	A = 120°
19mm Plaster thickness		

Catnic Plaster Beads are manufactured to BS EN 13658 : 2008 - Part 1 & 2.
Galvanised products are manufactured with steel in accordance to BS EN 10346: 2009-DX51D+Z275.

PVCu Beads

Catnic PVCu Plaster beads provide all the benefits of traditional metal beads, but with the added advantages of being a light, rigid, non-corrosive, easy to use material, offering elegant solutions for an aesthetic finish and providing a cost-effective way to comply with the latest regulations.

Features of PVCu Beads

PVCu plaster beads are designed to be used externally, where galvanised beads are not recommended, and internally in areas where high moisture or damp exist. They are an economical alternative to stainless steel.

PVCu Beads put a stop to the need for remedial work on internal applications where staining can sometimes be found with the use of galvanised beads as a result of prolonged drying out.

Material

Manufactured from virgin polyvinylchloride unplasticized (PVCu) which is impact-resistant, external window grade and UV stable.

- Eliminates cold-bridging
- Will not deteriorate during the lifetime of the coating

Excellent Adhesion

- Precision engineered perforation pattern
- 0.25mm high ribs at regular intervals
- Pro-Grip™ adhesion system for a stronger bond

High Durability

- Non-corrosive
- Impact resistant
- Withstands most site damage
- Exterior grade UV resistant
- Unaffected by weathering
- Resists chemical attack

Ease of use

- Simple to install
- Easy to cut
- Lightweight and safe handling
- No sharp metal edges to cause injury



Pro-Grip™

The range of PVCu Plasterer's beads from Catnic come complete with the Pro-Grip™ innovative adhesion system for a stronger bond.

Tiny grooves engineered into the face of the bead, ribs and undercut perforations increasing the surface area creating a stronger bond with the plaster or render. The Pro-Grip™ adhesion system prevents slippage often found with traditional PVCu beads, thus increasing the speed of application.



Blanc
RAL 9003



Ivoire
RAL 1015



Terre cuite
RAL 8203



Gris
RAL 7037



Marron
RAL 8014



Noir
RAL 9005

Colours

Catnic offer a great range of colours to suit a variety of plastering and render applications giving flexibility for both new build and refurbishment projects.

N.B. All colours are matched as closely as manufacturing and printing techniques allow.

Need another colour?

Simply supply us with a RAL number and Catnic can match PVCu Beads to suit any render or plaster colour.*

* Terms and conditions apply.

Installation Guide

Interior Applications – Plastering

Secure beads with plaster dabs or stainless steel staples every 600mm. When fixing, care should be taken not to distort the beads. In damp environments use only adhesive mortar dabs to secure.

Exterior Applications – Rendering

Use only adhesive mortar dabs to secure. Non-stainless mechanical pre-fixings should be removed before rendering. Beads used in a vertical plane plumb straight and dub out where necessary. Horizontal beads ideally should be set on a continuous bed of adhesive mortar.

When used in Thermal Insulation Systems, please observe the system specifications.

Cutting to length

Use fine toothed hacksaw or tin snips. PVC Pipe Weld adhesive can be used for butt joints in conjunction with link pegs where required.

Storage

Store flat, away from heat and direct sun.

Connectivity

Beads may be easily butted together using plastic link pegs (available for purchase on request).

Regulatory Compliance

Catnic's PVCu Beads conform to BS EN 13914-1: 2005.

PVCu Beads

Angle Beads

For use on all plastered and rendered corners where a true, sharp corner is required. Its strong rigid aris protects and reinforces plaster where it is most vulnerable.

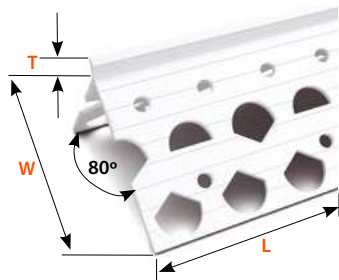

PVCu Angle Beads

PAB10/2.5	PAB12/2.5	PAB15/2.5	PAB19/2.5
6-10 depth mm	8-12 depth mm	15 depth mm	13-19 depth mm
50 per box	40 per box	30 per box	30 per box
T = 10mm	T = 12mm	T = 15mm	T = 19mm
W = 40mm	W = 40mm	W = 40mm	W = 40mm
L = 2.5m	L = 2.5m	L = 2.5m	L = 2.5m

Suitable for Internal and External use

PVCu Drip Beads

Used above doors, windows and at DPC level offering a profile flush with the rest of the render. The Drip Bead prevents the retention of water that can often bring staining at the bottom of the render.

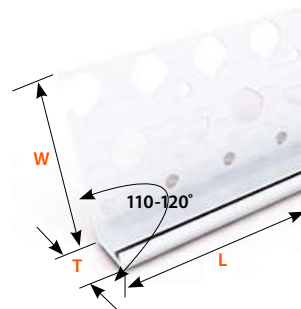

PVCu Drip Beads

PDB08/2.5	PDB10/2.5	PDB16/2.5	PDB19/2.5
8 depth mm	10 depth mm	16 depth mm	19 depth mm
50 per box	50 per box	50 per box	50 per box
T = 8mm	T = 10mm	T = 16mm	T = 19mm
W = 45mm	W = 45mm	W = 45mm	W = 45mm
L = 2.5m	L = 2.5m	L = 2.5m	L = 2.5m

Suitable for Internal and External use

PVCu Thin Coat Arch Beads

Readily bends to create curves and arch forms for decorative plaster requirements in thin coat and dry-lining applications.

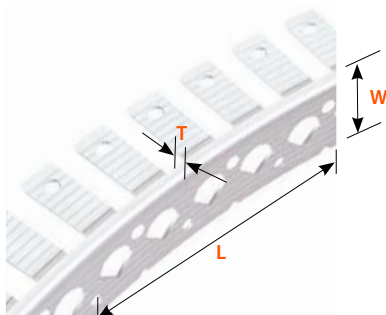

PVCu Angle Beads

PAR03/2.5
3 depth mm
W = 24mm
50 per box
L = 2.5m
T = 3mm

Suitable for Internal and External use

PVCu Twin Nose Angle Beads

A bead suitable for twin-coat render work. The first nose acts as a gauge for a scratch coat and the second nose acts as a depth gauge for the finishing coat.

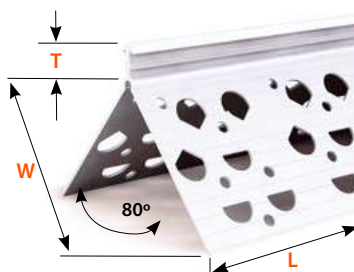

PVCu Twin Nose Angle Beads

PTN12/2.5
8-12 depth mm
W = 26mm
30 per box
L = 2.5m
T = 12mm

Suitable for Internal and External use

PVCu Thin Coat Angle Beads

Provides a true, clean corner for plasterboard or any smooth background. Protects and reinforces plasterboard joints to minimise cracking.

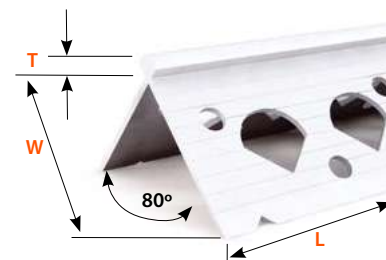

PVCu Thin Coat Angle Beads

PAB03/2.5
3 depth mm
W = 24mm
50 per box
L = 2.5m
T = 3mm

Suitable for Internal and External use

PVCu Beads

PVCu Bell Cast Bead (Render Stop Bead)

Designed to deliver a gentle gradient at the base of the render, it is used above doors, windows and at DPC level to allow rainwater to drain clear of the underlying substrate.

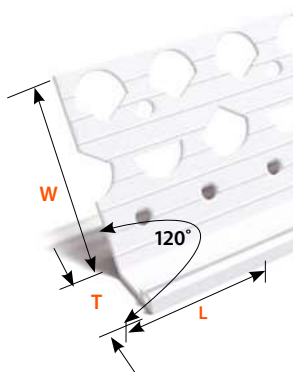

PVCu Cast Bell Beads		
PBC10/2.5	PBC15/2.5	PBC20/2.5
6-13 depth mm	10-16 depth mm	12-22 depth mm
50 per box	50 per box	50 per box
T = 14mm	T = 20mm	T = 25mm
W = 45mm	W = 45mm	W = 45mm
L = 2.5m	L = 2.5m	L = 2.5m

Suitable for Internal and External use

PVCu Architrave bead with flange

Gives a shadow line decorative effect for aesthetic purposes and creates a clean division between varying wall finishes.

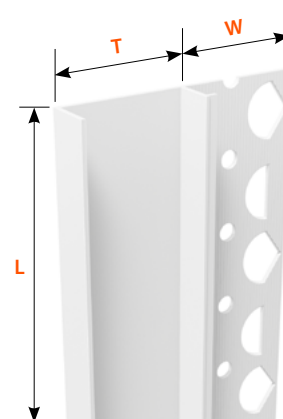

PVCu Architrave bead with flange
PAT1325/3.0/WH
13 depth mm
50 per box
T = 25mm
W = 25mm
L = 2.5m, 3.0m

Suitable for Internal and External use

PVCu Movement Beads

Used where the underlying substrate changes, or where minor movement in the structure beneath the render is expected. Movement beads can also be used where changes in render colour are specified. Movement beads should NOT be used over structural movement joints.

PVCu Movement Beads				
PMBS06/2.5	PMBS08/2.5	PMBS10/2.5	PMBS15/2.5	PMBS20/2.5
6 depth mm	8 depth mm	10 depth mm	15 depth mm	20 depth mm
25 per box	25 per box	25 per box	25 per box	25 per box
T = 6mm	T = 8mm	T = 10mm	T = 15mm	T = 20mm
W = 60mm	W = 60mm	W = 60mm	W = 60mm	W = 60mm
L = 2.5m	L = 2.5m	L = 2.5m	L = 2.5m	L = 2.5m

Suitable for Internal and External use

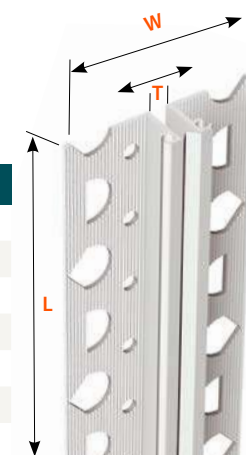

PVCu Plasterstop Beads

Used on door and window openings also at base of wall and ceiling level. Designed to deliver a clean edge, they protect and finish plaster and render edges.

PVCu Plaster Stop Beads						
PPS03/2.5	PPS06/2.5	PPS08/2.5	PPS10/2.5	PPS15/2.5	PPS20/2.5	PWW15/2.5
3-4 depth mm	6-8 depth mm	8-10 depth mm	10-12 depth mm	15-17 depth mm	20-22 depth mm	15 depth mm
50 per box	50 per box	50 per box	50 per box	50 per box	50 per box	50 per box
T = 3mm	T = 6mm	T = 8mm	T = 10mm	T = 15mm	T = 20mm	T = 15mm
W = 27mm	W = 45mm	W = 45mm	W = 45mm	W = 45mm	W = 45mm	W = 58mm
L = 2.5m	L = 2.5m	L = 2.5m	L = 2.5m	L = 2.5m	L = 2.5m	L = 2.5m

Suitable for Internal and External use

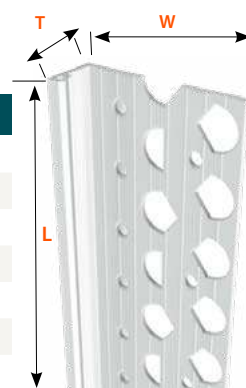

External Wall Insulation (ewi)

External Wall Insulation (EWI) is an insulated layer applied to the exterior wall of a building and covered with a render coat. An EWI system can significantly improve the thermal performance of a building by reducing the rate at which heat is lost through the walls.



In addition this system can dramatically transform the buildings exterior with a wide range of contemporary or traditional finishes using different textures, colours or finished effects. The result is a comfortable living environment with reduced heating costs for the occupants and an increase in property value with extended lifespan.

Catnic supplies a range of base track and bead components designed for EWI systems. Our EWI product range is manufactured to the same industry-leading high standards as our renowned steel lintels.

In 2013 Catnic became an associated member of the Insulated Render and Cladding Association (INCA).

External Wall Insulation

Base Track

The aluminium channel provides a simple means of locating and levelling the bottom run of insulation boards.

The channels are available in different sizes to suit a range of different insulation thickness.

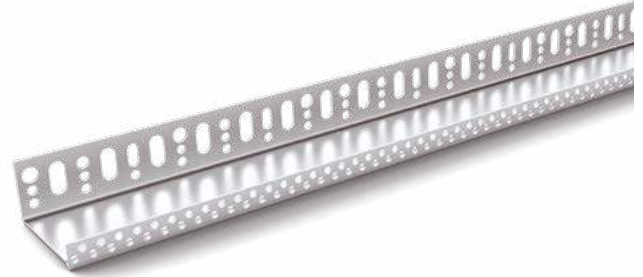

Base Track

Product Code	Length (m)	Lengths/pack	To suit insulation thickness (mm)	Overall Width (mm)*	Gauge (mm)
8145	2.5	10	50	53	0.8
8148	2.5	10	80	83	0.8
8150	2.5	10	100	103	0.8
8152	2.5	10	120	123	1.0
8154	2.5	10	140	143	1.0

*Other sizes are available to order

Base Track Clip with Mesh

The PVC mesh clip is designed to fix onto the Base Track, providing a drip edge to protect against water ingress and ensure a professional finish.

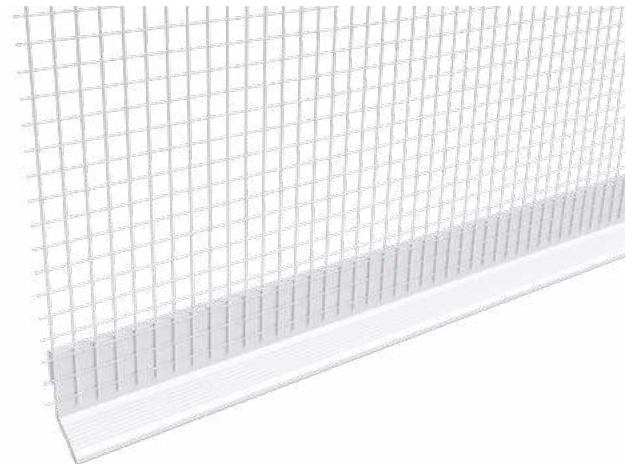

Base Track Clip with Mesh

Product Code	Length (m)	Lengths/pack	Render Depth (mm)	Material
8007	2.5	25	7	PVC with mesh

External Wall Insulation

Mesh Corner Bead

For use on all rendered corners where a true, sharp corner is required.

The corner bead protects and reinforces the corners of the insulation boards, while the mesh ensures there are no cracks in the render.

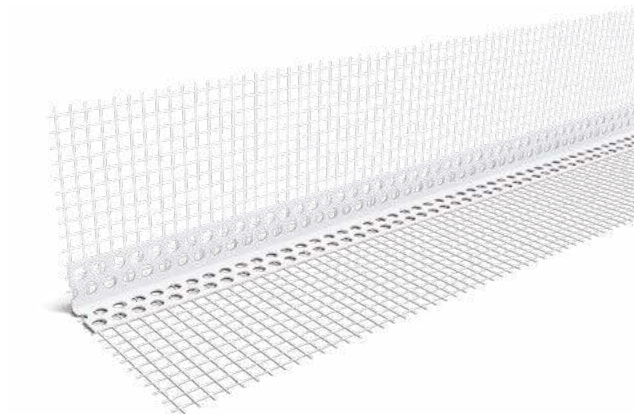
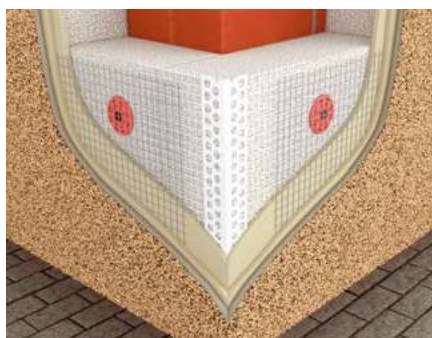

Mesh Corner Bead

Product Code	Length (m)	Lengths/pack	Mesh Overlap (mm)	Material
8409	2.5	100	60 x 90	PVC with mesh
8410	2.5	100	80 x 120	PVC with mesh
8415	2.5	100	100 x 150	PVC with mesh
8423	2.5	50	100 x 230	PVC with mesh

Drip Bead with Mesh

To be fixed onto horizontal edges, such as door and window heads, to prevent the retention of water that can often bring staining at the bottom of the render.

It includes bevelled and grooved edges for better plaster adhesion.



Drip Bead with Mesh

Product Code	Length (m)	Lengths/pack	Mesh Overlap (mm)	Material
8407	2.5	25	100 x 100	PVC with mesh

External Wall Insulation

Stop Bead with Mesh

Finishing sections for rendering with a fibre mesh strip to reinforce edges of the thermal insulation system.

Designed to deliver a clean, neat edge, they protect and finish plaster and render edges.

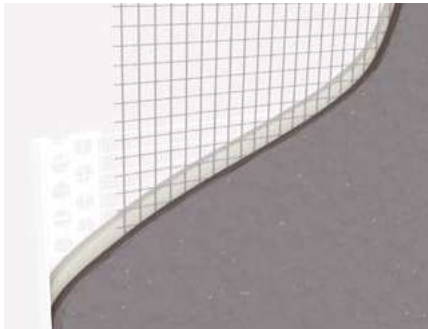
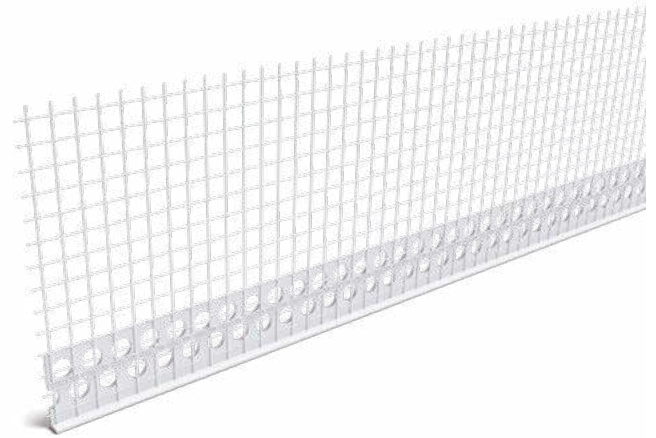

Stop Bead with Mesh

Product Code	Length (m)	Lengths/pack	Plaster Depth (mm)	Material
8403	2	25	3 - 4	PVC with mesh
8406	2	25	6 - 8	PVC with mesh

Window Frame Seal without Mesh

Used as a stop bead to give a clean, simple detail where the rendered reveal meets the window frame.

The bead incorporates a compressible foam tape to allow it to seal against the window frame. It also has an adhesive strip to temporarily fix a protective sheet over the window while rendering. When rendering is completed this section of the profile with the adhesive strip is simply removed.



Window Frame Seal without Mesh

Product Code	Length (m)	Lengths/pack	Plaster Depth (mm)	Material
3040M	2.4	60	6	PVC
3140L0	1.4 / 2.4 / 2.6	60	9	PVC

External Wall Insulation

Window Frame Seal with Mesh

Used as a stop bead, where the reveal meets the window frame, it gives a clean, simple detail while the mesh reinforces the detail, ensuring a good adhesion to the insulation layer.

The bead with 120mm mesh incorporates a compressible foam tape to allow it to seal against the window frame. It also has an adhesive strip to temporarily fix a protective sheet over the window while rendering. When rendering is completed this section of the profile, with the adhesive strip, is simply removed.

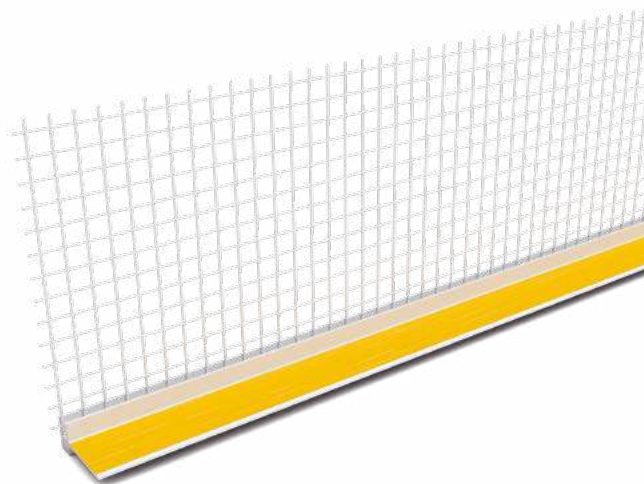

Window Frame Seal with Mesh

Product Code	Length (m)	Lengths/pack	Plaster Depth (mm)	Material
3040GL	2.5	60	6	PVC with mesh
3140GL	1.4/2.4	60	9	PVC with mesh

Fibreglass Mesh

Fibreglass mesh provides a layer of reinforcement between the insulation and final topcoat or finish.

Product features include:

- Full Heat Protection Mesh
- Displacement Resistant
- Alkaline Resistant
- Alcohol and Water Resistant
- Chemically Finished



Fibreglass Mesh

Fibremesh Rolls

Code	FM165	Colour	White	Mesh Size (mm)	4 x 4mm
Description	Fibreglass Mesh Roll	Width (mm)	1000mm	Weight	165g/m ²
Application	Render reinforcement	Length (m)	50m	Quantity	Each

External Wall Insulation

Duo-Base Base Profiles

The variable base system for 100–260 mm of insulation thickness



DuoBase base profile

8180 – 200 cm

Two-part PVC

Length in cm: 200

PU = 10 bars/bundle

Insulation thickness 100–160 mm

DuoBase outer corner

8190 – 100 cm

5 PVC corners (5 right corners and 5 left corners)

Length in cm: 100

PU = 5 bars/bundle

Insulation thickness 100–160 mm

DuoBase 100–160 mm

WP: 100 mm / FP: 100 mm



DuoBase base profile

8181 – 200 cm

Two-part PVC

Length in cm: 200

PU = 10 bars/bundle

Insulation thickness 160–220 mm

DuoBase outer corner

8191 – 100 cm

5 PVC corners (5 right corners and 5 left corners)

Length in cm: 100

PU = 5 bars/bundle

Insulation thickness 160–220 mm

DuoBase 160–220 mm

WP: 100 mm / FP: 160 mm

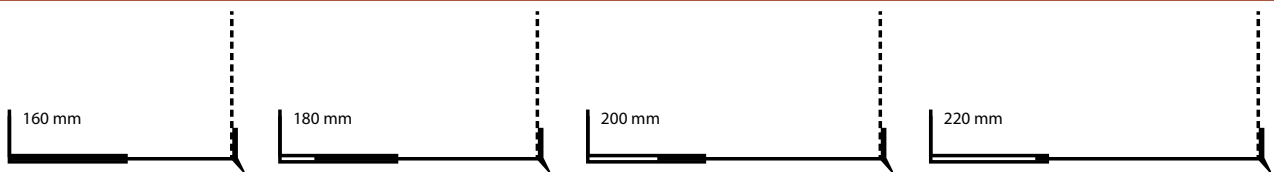

Properties

Material (plastic)	Rigid PVC, white, UV-stabilised, impact-resistant
Material (fibre)	ETICS fibre, alkali-resistant, approx. 165 g/m ²
Material bond	Fibre is moulded in the PVC profile through material and form-fitting co-extrusion
Holes	Round and oval
Profile connector	Not required due to overlapping front profile attached

Image/diagram

Wall profile (WP)



Front profile (FP)

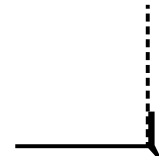

Outer corners ready for assembly

Ten front profiles are cut mitred in pairs (45°).
For installation, the front profiles are inserted in the installed wall profile.
The wall profile does not have to be mitre cut for this.

Edge lengths: 100 cm

Packaging unit: 5 outer corners (5 left and 5 right profiles)

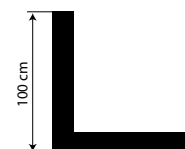

Images are not to scale

Expanded Metal Lath

Catnic metal lath is easy to fix and provides a secure key for many plaster and render applications including joint and crack reinforcement and refurbishment work. Available in Rib form as a plaster backing on ceilings, walls and stud partitions or Diamond form that can be used as part of a fire protection system for structural steel work.

Diamond Lath

Expanded metal lath is extensively used as a background to plaster in order to reinforce against cracks and it is especially useful at joints of dissimilar materials. Generally DL111 or DL089 lath is used for wall situations and DL161 is used for ceiling work.

Sheet Lath

Reference	SW Mesh (mm)	Weight (kg/m ²)	Material	Sheet size (cm)
DL089	9	0.9	Galvanised Steel	250 x 70
DL111	9	1.11	Galvanised Steel	250 x 70
DL161	9	1.61	Galvanised Steel	250 x 70
DL111S	9	1.11	Stainless Steel	250 x 70

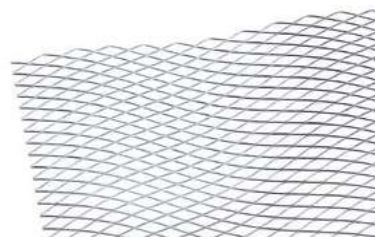

Strip Lath

Reference	Weight (kg/m ²)	Width (cm)	Material	Length (cm)
SL021/100/2.5	1.11	10	Galvanised Steel	250
SL021/150/2.5	1.11	15	Galvanised Steel	250
SL023/100/2.5	1.61	10	Galvanised Steel	250
SL023/150/2.5	1.61	15	Galvanised Steel	250

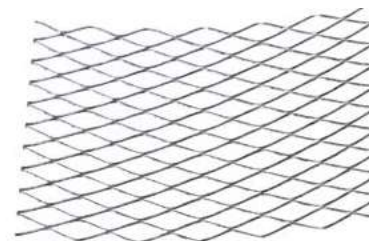

Coil Lath

Reference	Weight (kg/m ²)	Width (cm)	Material	Coil length (metres)
CL021/100/100	1.11	10	Galvanised Steel	100 - 50
CL021/150/100	1.11	15	Galvanised Steel	100 - 50
CL021/200/100	1.11	20	Galvanised Steel	100 - 50
CL023/100/100	1.61	10	Galvanised Steel	100 - 50
CL023/150/100	1.61	15	Galvanised Steel	100 - 50
CL023/200/100	1.61	20	Galvanised Steel	100 - 50

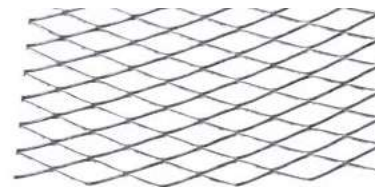

Quality: Manufactured from galvanised steel to BS EN 10346: 2009 – DX51D+Z275 or Stainless Steel to BS EN 10088-2-1.4301. All products shown are manufactured in accordance with BS EN 13658: 2005. Metal Lath - Definitions, Requirements, Test Methods. Part 1 for Internal Plastering. Part 2 for External Plastering.

Expanded Metal Lath

Rib Lath

Extensively used as a plaster background for ceilings, walls and partitions. Generally Rib 148 is suitable for wall situations. For ceiling work 184/222 should be used.

Sheet Lath				
Reference	Weight (kg/m ²)	Material	Size (cm)	Rib Height (mm)
RIB148	1.48	Galvanised Steel	250 x 60	10
RIB184	1.84	Galvanised Steel	250 x 60	10
RIB222	2.22	Galvanised Steel	250 x 60	10
RIB148 S	1.48	Stainless Steel	250 x 60	10
RIB184 S	1.84	Stainless Steel	250 x 60	10



Stainless steel fixings should be used at sufficient intervals to hold the lath firmly in position.

Refurbishment of Masonry

Stainless steel rib lath is ideal for refurbishing damaged or aged masonry walls, when a key for rendering is not certain due to disintegration or softening of the wall face.

Lath should be fixed with apexes of ribs against the wall, edge ribs of the sheets nesting into each other should be wire-tied every 15cm and ends of sheets should be lapped not less than 2.5cm and nesting ribs securely tied together.

Quality: Catnic expanded rib lath is manufactured in accordance with BS EN 13658: 2005. Metal Lath - Definitions, Requirements, Test Methods. Part 1 for Internal Plastering. Part 2 for External Plastering. The galvanised steel used in the manufacture of rib lath is in accordance with BS EN 10346: 2009 – DX51D+Z275. Where stainless steel is used it is in accordance with BS EN 10088-2-1.4301.

Coil Mesh for Blockwork

Coil Mesh - Galvanised & Stainless Steel

Anti-crack reinforcement for non-structural use.

Coil Mesh			
Reference	Wall width (mm)	Coil width (mm)	Coil length (metres)
CM 50	100	50	50 or 20
CM 64	114	64	50 or 20
CM 100	150	100	100, 50, 20
CM 114	164	114	100, 50, 20
CM 150	200	150	100, 50, 20
CM 178	228	178	100, 50, 20
CM 200	250	200	100, 50, 20
CM 229	279	229	100, 50, 20
CM 305	355	305	100, 50, 20



Coil Mesh for Non Structural Usage

Expanded metal type bed joint reinforcement is supplied as an anti-crack reinforcement in the design and construction of brick and block masonry.

It is generally provided at areas of high stress concentration to dissipate these stresses to areas of low stress. A typical example would be at a point where the section of wall changes, such as at a door or window opening.

The cracking of masonry due to changes in temperature, changes in moisture content and settlement of foundations can all be controlled by the use of block reinforcement.

BS EN 1996 1-1
PD 6697

Mesh Arch Formers

Mesh Arch Formers

The easy way to create attractive and perfectly finished arches.

For walls of up to 160mm thick, the frame sections are designed to be overlapped. For walls 160-300mm thick, standard infill soffit pieces are provided to bridge the gap between the sections.

If the thickness of the wall is between 300-565mm, an Extra Soffit piece is available. Each arch is supplied with installation instructions and a complete fixing kit. Soffit pieces are also included for walls up to 300mm thick.

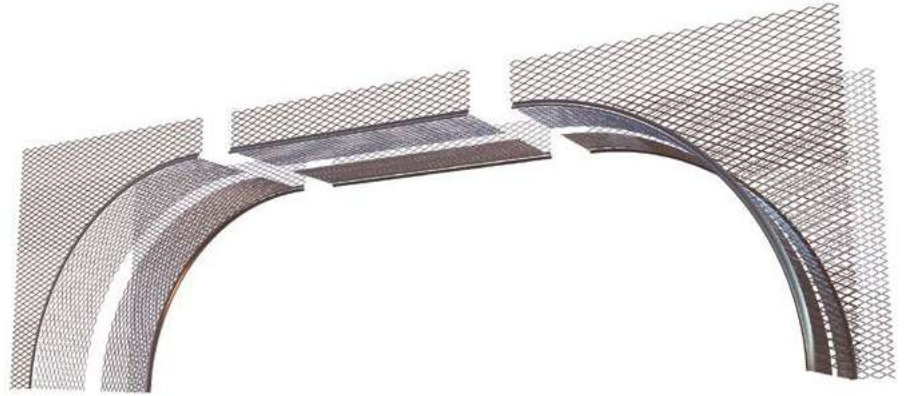

Verona

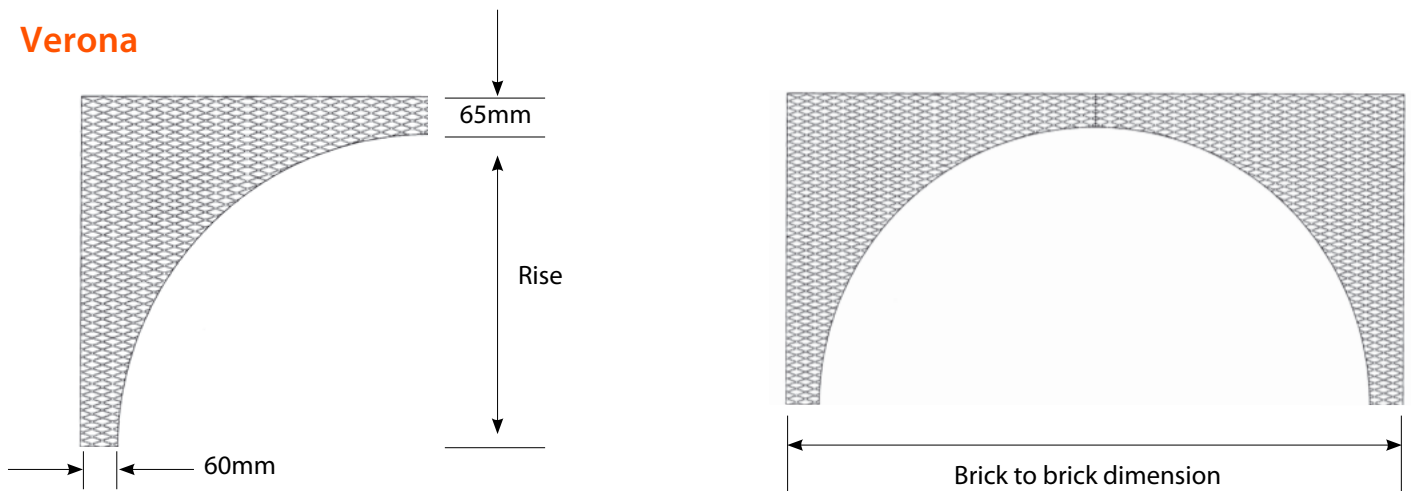

Verona with bridging sections

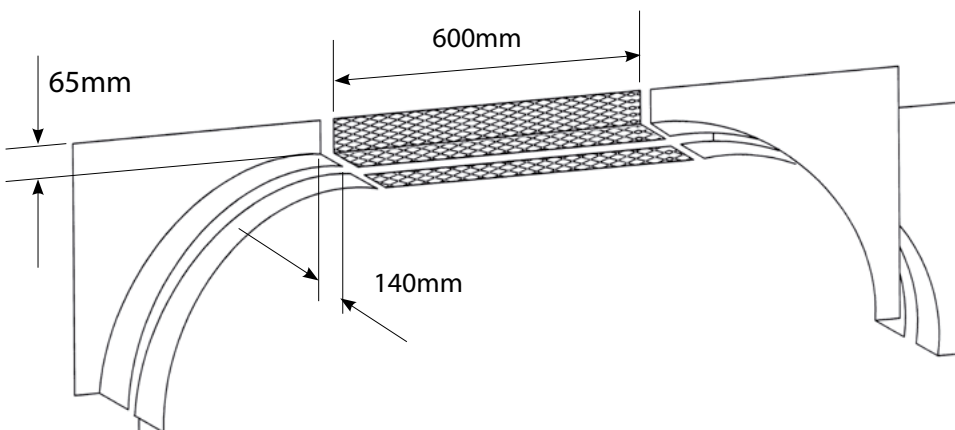

Extra soffit section

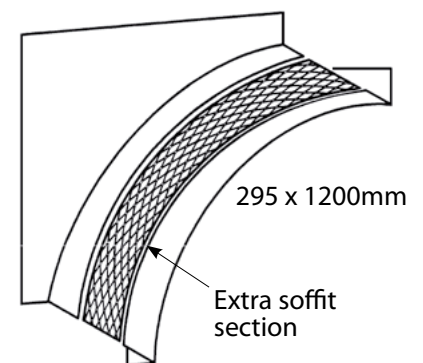

Mesh Arch Formers

Verona Metal Arch Formers

Part code	Brick to brick dimension (mm)	Rise (mm)
VE 0750	750	375
VE 0800	800	400
VE 0850	850	425
VE 0900	900	450
VE 1200	1200	600
VE 1500	1500	750

Bridging Section

Part code	Length
BS 0610	600mm

Extra Soffit Section

Part code	Size	Wall thickness
ES 0295	295 x 1200mm	300 - 565mm

Installation



- 1 Measure the distance between the walls (brick to brick) and select the appropriate arch size. If renovating, remove existing plaster down to the masonry. Mark the centre of the aperture.
- 2 Position the first section of the arch to the wall and fix with the masonry nails provided.
- 3 Fix the other sections in the same way, aligning them at the centre with the plastic joining pieces provided. All arches and soffit pieces should be joined with the self tapping screws provided.
- 4 The arch is completed by plastering directly onto the steel mesh, using a suitable material.

Quality: The galvanised steel used in the manufacture of mesh arch formers is in accordance with BS EN 10346: 2009 – DX51D+Z275.

SecuraMesh™

Expanded metal security mesh.

SecuraMesh™ by **catnic**®

These sheets of expanded steel mesh fit neatly into internal and external walls, ceilings and roofs to defend premises against forced entry. Resistant to bolt and hand cutters, SecuraMesh™ is the extra layer of security it pays to put in place.

- **Manufactured in the UK**
- **Available in medium and heavy duty gauges**
- **Options to suit both dry-lined and render finish applications**

The benefits of SecuraMesh™

- Concealed, robust protection from break-ins
- Diamond mesh profile is too small for bolt cutters and too strong for hand cutters
- Manufactured from one sheet so strands don't unravel during installation
- Can be installed during or after initial construction
- Available in mild steel as standard or galvanised mild steel for additional corrosion protection

Important note on installation

To achieve the additional protection offered by SecuraMesh™ installers must strictly adhere to the installation guidelines.

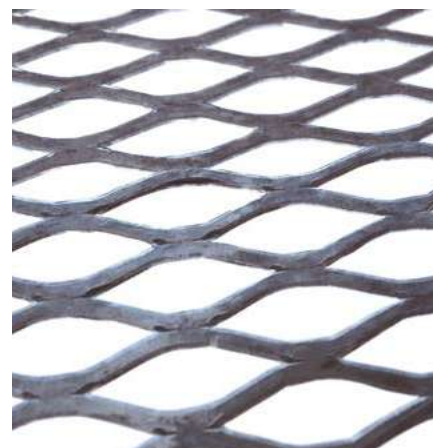

SecuraMesh™

Material Specification

All SecuraMesh™ products are manufactured from mild steel, following specification and tolerances set out in BS405 (1987).

Where galvanised products are required they are post galvanised to BS EN 1461: 1999

Catnic operate a continuous development programme and we reserve the right to amend specification without prior notification.

Storage

Unless required for immediate use on site, all SecuraMesh™ products should be stored in a clean and dry environment and should be protected from moisture during shipment.

SecuraMesh™ should be stored on pallets or suitable racking where practicable. Do not leave items projecting that could cause injury and avoid storage in high traffic areas where risk of damage is increased.

Handling Precautions

Gloves should be worn to avoid injury from any sharp edges. In the event of a cut, the injury is to be treated by a trained first-aider.

When lifting or carrying, consideration must be given to the size and weight of the product. Caution should be exercised when mechanical handling, ensuring the load is evenly balanced and the straps or slings secure.

Uses

All SecuraMesh™ products should be used in accordance with the Company's recommendations and comply with the details shown on the architects'/engineers' drawings. Specifiers must ensure that the resulting finish will be suitable for the intended application.

For design and specification information please refer to the British Standards listed in this brochure and to the manufacturers' literature.

Disposal

Do not use damaged goods. Packaging to be removed with care and disposed of in a safe manner. When disposing of any Catnic products or packaging, due consideration must be given to the environmental impact of the method of disposal.

COSHH

We are not aware of any risk to the person, arising from chemicals or any other substances present on or in our products. All COSHH related queries should be directed to our Technical Services Department on **+44 (0) 29 2033 7900.**

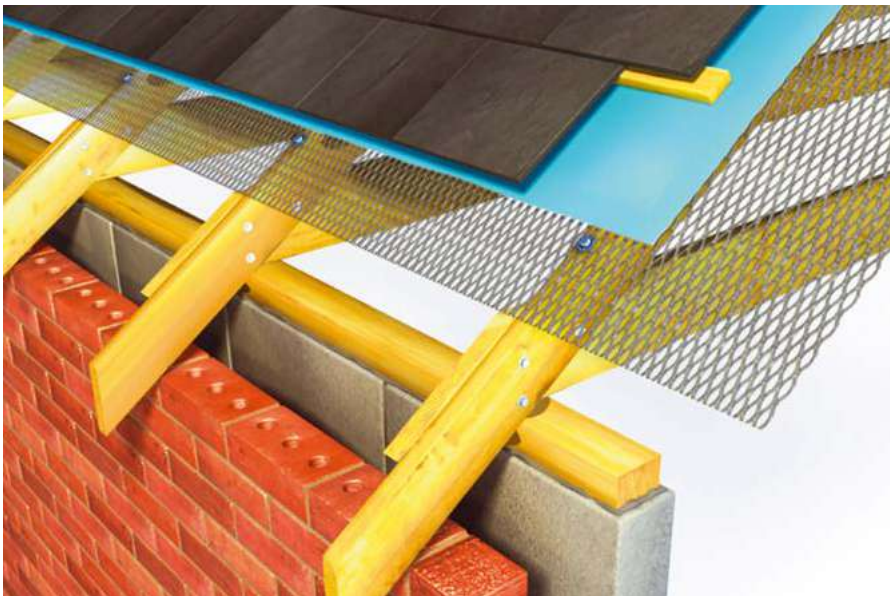

SecuraMesh™

SMMD - Medium Duty Security Mesh

A medium-duty security mesh suitable for internal wall security, partitions, ceilings and roofs.



SMMD		
Product Code	SMMD01	SMMD02
Description	1.2mm thick flattened mesh	1.2mm thick flattened mesh
Mesh Aperture LWD (mm)	43.3	43.3
Mesh Aperture SWD (mm)	18.0	18.0
Strand width (mm)	2.3	2.3
Strand thickness (mm)	1.1	1.1
Weight (kg/m ²)	1.85	1.89
Sheet Size (mm)	2440 x 1220	2440 x 1220
Material	Mild Steel	Galvanised Steel

SMHD - Heavy Duty Security Mesh

A heavy-duty security mesh suitable for internal wall security, partitions, ceilings and roofs.



SMHD		
Product Code	SMHD01	SMHD02
Description	3.0mm thick flattened mesh	3.0mm thick flattened mesh
Mesh Aperture LWD (mm)	42.9	42.9
Mesh Aperture SWD (mm)	14.2	14.2
Strand width (mm)	4.6	4.6
Strand thickness (mm)	2.7	2.7
Weight (kg/m ²)	8.59	8.81
Sheet Size (mm)	2440 x 1220	2440 x 1220
Material	Mild Steel	Galvanised Steel

SMHR - Heavy Duty Raised Security Mesh

A heavy-duty raised security mesh suitable for internal or external brickwork and acts as keys for render or plaster finishes when galvanised.



SMHR		
Product Code	SMHR01	SMHR02
Description	3.0mm thick mesh with raised finish	3.0mm thick mesh with raised finish
Mesh Aperture LWD (mm)	50.8	50.8
Mesh Aperture SWD (mm)	22.6	22.6
Strand width (mm)	3.1	3.1
Strand thickness (mm)	3.0	3.0
Weight (kg/m ²)	6.52	6.69
Sheet Size (mm)	2440 x 1220	2440 x 1220
Material	Mild Steel	Galvanised Steel

SecuraMesh™

Applications

Popular applications

Retail	Commercial & Industrial	Arts	Public Service
Retail outlets	Record storage rooms	Museums	Secure units
Cashier kiosks	Computer server rooms	Art galleries	Airport security
Pharmaceutical stores	Control rooms	Libraries	Hospitals

Roofs

Recommended: SMMD

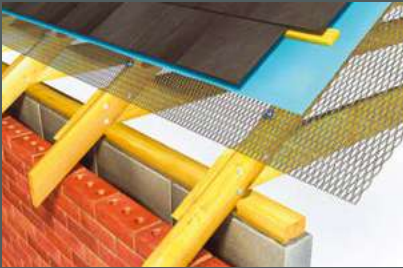

Fixings: Fixed to stud with 30-38mm galvanised staples, 30-38mm galvanised screw-nails, or 65mm x 3.35mm bright annular nails (to BS1202) and min 25mm dia x 1.5mm galvanised washers fixed at maximum 450mm centres.

Ceilings

Recommended: SMMD or SMHD



Fixings: Fixed to stud with 30-38mm galvanised staples, 30-38mm galvanised screw-nails, or 65mm x 3.35mm bright annular nails (to BS1202) and min 25mm dia x 1.5mm galvanised washers fixed at maximum 450mm centres.

Masonry

Recommended: SMHR



Fixings: Suitable for both render and plaster finishes. SMHR SecuraMesh™ fixed with either suitable shot fired fixing, or plug and M6 x 50mm screw and plug, complete with minimum 25mm dia x 1.5mm galvanised washers at maximum 450mm centres.

Timber Stud Walls

Recommended: SMMD or SMHD



Fixings: Fixed to stud with 30-38mm galvanised staples, 30-38mm galvanised screw-nails, or 65mm x 3.35mm bright annular nails (to BS1202) and min 25mm dia x 1.5mm galvanised washers fixed at maximum 450mm centres.

Metal Stud Walls

Recommended: SMMD or SMHD



Fixings: Fixed to metalwork with No 6 or 8 x 30 zinc plated self tapping screws, complete with 25mm dia x 1.5mm galvanised washers fixed at maximum 450mm centres.

Wall Accessories

Catnic Wall Connectors are a simple yet effective system for tying new masonry walls to existing walls.

Wall Connectors

Catnic wall connectors are suitable for wall thicknesses from 60mm up to 250mm and one pack contains all of the required fixings for a single wall of 2.4m high. This product is available with a choice of two different materials.

Stronghold Wall Connectors

SWC

Stainless Steel to BS EN 10088-2

20 packs per carton



Galvanised Wall Connectors

GWC

Galvanised Steel to BS EN 10327: 2004-DX51D+Z275

20 packs per carton



Wall Ties

Cavity wall ties provide stability to masonry walls and care should be taken during installation to avoid the ingress of water to the inner skin and potential failure. Wall ties should be installed in accordance to guidance given in BSI PD 6697.

(formerly BS5628 Code of Practice for use of masonry)

- Wall Tie embedment should be at least 50mm in both leaves
- Wall Tie should be bedded into mortar and not placed onto dry masonry with mortar applied around the wall tie
- Density should not be less than 2.5 ties per square metre with density increased vertically around openings (900mm Horizontally, 450mm Vertically) Cavity Wall Ties are classified in to four types as detailed in Table 10 of BSI PD 6697 : 2010

Classification of wall tie by end use (as BSI PD 6697 : 2010)

Classification	Type of Structure	Geographical Location
Type 1 (Masonry: Heavy Duty)	Suitable for most masonry cavity and cladding walls and most building sizes and types. Not very flexible and should not be specified where large adjustments are likely to be needed during construction, where large differential movements are expected to take place between the leaves, or where very low strength/density masonry units are in use.	Suitable for most sites. However, for relatively tall buildings in the north western fringes of the UK - particularly on coastal sites - and for buildings of unusual shapes, the necessary tie provision should be calculated.
Type 2 (Masonry: General purpose)	Suitable for domestic dwellings and small commercial buildings of a height of up to 15m above ground level, made with box-form masonry walls comprising two leaves of brickwork of similar thickness in the range 90mm to 150mm. May be suitable for cavity walls having leaves of disparate thickness or stiffness or for cladding walls (having none or limited horizontal spanning capability) and for building exceeding 15m, but only if shown to be adequate performance by calculation.	Suitable for buildings on flat sites where the fundamental basic wind speed velocity is up to 31 m/s except areas where the site is at an altitude of 150m or more above sea level. May be adequate for higher altitudes and sloping sites exceeding a slope of 1 in 20 if calculated.
Type 3 (Masonry: Basic)	As Type 2.	As Type 2 but fundamental basic wind velocity limited to 27 m/s.
Type 4 (Masonry: Light Duty)	Suitable only for masonry cavity walls, comprising two leaves of similar thickness in the range of 90mm to 150mm, in box form domestic dwelling of up to 10m in height. Not suitable for cavity walls having disparate thickness or stiffness, for cladding walls of any type or for multi-storey structures of more than three storeys. Suitable for internal separating cavity walls in most buildings.	Suitable for flat sites within towns and cities anywhere in the UK except in the north western fringes of Scotland and Ireland (where fundamental basic wind velocity exceeds 27 m/s) and any areas where the site is above an altitude of 150m or more above sea level.

Wall Ties

All Catnic wall ties are manufactured from high quality stainless steel wire and strip materials to ensure that structural design and properties are maintained throughout the life cycle of the structure.

BB-2			
Length	Width	Cavity width	Packing
191mm	19mm	50mm	Cartons of 250
DD140 Part 2 1987 type 2 requirement			Catnic BB-2
Tensile Load (N)	At serviceability	500	1321
Tensile Load (N)	At failure	1800	3183
Comprehensive Load (N)	At serviceability	400	552
Comprehensive Load (N)	At failure	1300	1300



BB-3			
Length	Width	Cavity width	Packing
220mm	19mm	75mm	Cartons of 250
DD140 Part 2 1987 type 2 requirement			Catnic BB-3
Tensile Load (N)	At serviceability	500	1529
Tensile Load (N)	At failure	1800	4051
Comprehensive Load (N)	At serviceability	400	1540
Comprehensive Load (N)	At failure	1300	2374



Fixings: For fixing masonry to masonry in cavity walls of domestic houses and small commercial buildings of up to three storeys but not exceeding 15m in height. Tie density 2.4 ties/m². Based on a design windspeed up to 56m/s.

BT 2-4			
Length	Width	Cavity width	Packing
120mm	19mm	50mm	Cartons of 250

Fixings: For fixing masonry to timber framing in single and two storey dwellings up to a maximum height of 8m. Also suitable for block to concrete applications. Tie density and windspeed refer to BBA certificate..



Stainless Steel Strip Ties					
Cavity	Design	Tie Size (mm)	Specify	DD140: Part 2	Wind Speed
50mm	3 storeys up to 15m	0.6 x 19 x 191	BB-2	Type 2	Up to 56m/s
50mm	5 storeys up to 15m	0.8 x 19 x 220	BB-3	Type 2	Up to 56m/s
50mm	4 storeys up to 12m	0.6 x 19 x 120	BT 2-4		Up to 56m/s

Wall Ties

Catnic Wall Ties are manufactured from stainless steel in accordance with BS EN 10088-2-1.4301 (strip), BS EN 10088-3:2005 min. 18/8 composition (wire).

Double Triangular Wall Tie

Ref: DTWT

Double triangular Wall Ties are Manufactured from Stainless Steel Wire with a diameter of 3.3mm and Manufactured to BS EN 845-1:20033 and tested to BS EN 846-5:2000

Available lengths are:

Length Cavity Width
200mm 50mm - 75mm
225mm* 76mm - 100mm

Double Triangle Wall Ties DTWT are classed:

Type 2 (Masonry: General Purpose)

* Additional lengths available: 150mm, 200mm, 225mm, 225mm 250mm, 275mm, 300mm



Insulation Retainer

Ref: IRC85

Polypropylene insulation retainer, 85mm diameter.

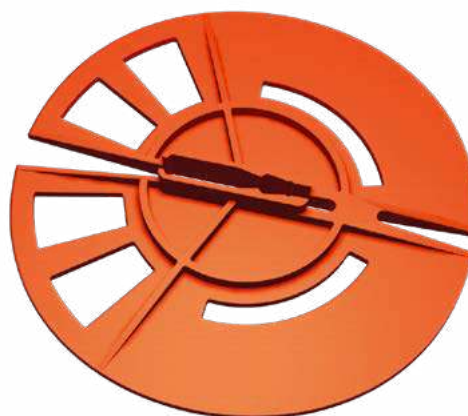

Dovetail Slots & Ties

Dovetail Slots

Ref: CDTS3000, CDTS100, CDTS150

Dovetail Channels are a cast in channel slot allowing vertical movement and horizontal restraint. Manufactured from Grade 304 stainless steel and are pre-filled with polystyrene to prevent the ingress of concrete during the installation stage.

Dovetail Slots are used in conjunction with safety-end ties. Can also be used with DeBonding Sleeves (CDS) where lateral movement is required.

Dovetail slots should be cast in-situ at a minimum of 50mm from the edge of the wall.

Available lengths are:

3000mm - Bundles of 10
100mm - Boxes 100
150mm - Boxes 100



Dovetail Slot Ties

Ref: CDTST/ ... /SS

Projection lengths available:

75mm 100mm 125mm 150mm 175mm
200mm 225mm 250mm & 300mm



CDTS Dovetail Safety End Ties

Length

75-300mm

Tensile Load (Cast in)	2960N
Tensile Load Mortar End	5284N

75-200mm

Comprehensive Load Capacity	4896N
-----------------------------	-------

225-300mm

Comprehensive Load Capacity	1470N
-----------------------------	-------

Important note: Specifiers now use various wire diameters, if possible please check specification. Note: BS5628 part 2 recommends that Stainless Steel material should be used on an external wall, including the inner leaf of a cavity wall.

Head Restraint Fixings

Internal Head Restraint

Ref: CHR215

Head restraints are used to restrain the top of a masonry free standing wall through fixing to the underside of the concrete slab, preventing sideways movement.

Head restraint fixings allow for vertical movement to accommodate shrinkage or thermal movement of the structural frame, while restraining lateral loads.

Head restraint fixing are generally fixed at 450mm or 900mm dependant on the load applied at the head of the masonry.

Available lengths are:

Head restraint Fixing are 215mm and in box of 50 pieces



Head Restraint

Ref: CHR

Designed to restrain the inner leaf of a cavity wall. Manufactured as two angles with holes positioned to accommodate 100mm & 140mm clock thickness. 215mm block thickness also available.

Fixed using an MB fixing anchor (set at torque setting 15Nm) to the underside of the slab.

Supplied in boxes of:

50 pieces



Bed Joint Reinforcement - Ladder Type

Ladder Type

Ref: CLBR

Ladder type Bed Joint Reinforcement with outer wires and welded cross wires. Generally used in structural masonry or anti-crack control. Conforms to BS5268: Part 2 2000.

Available lengths are:

Ladder bed Joint Reinforcement comes in bundles of 10 x 2.7m lengths.

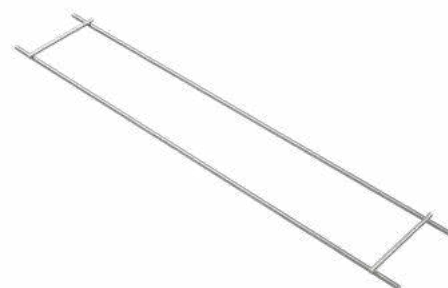

Available in Stainless Steel Grade 304 S15. Galvanised also available

CLBR3		
Product Ref.	Product Width	Wall Width
CLBR3/60/2.7	60mm	100mm
CLBR3/100/2.7	100mm	140mm
CLBR3/150/2.7	150mm	190mm
CLBR3/175/2.7	175mm	215mm
3mm outer wires with 2.5mm cross wires		
Length	2700mm +/- 1.5%	
Profile Height	3.5mm +/- 0.4mm	
Longitudinal Wire Size	3.0mm +/- 0.1mm	
Cross Wire Size	2.5mm +/- 0.1mm	
Pitch of Cross Wires	450mm +/- 3.0%	
Characteristics Yield Strength	500N/mm ²	
Lap Length	225mm	
Shear Load Capacity Wields	2988N	

CLBR3 6		
Product Ref.	Product Width	Wall Width
CLBR3.6/60/2.7	60mm	100mm
CLBR3.6/100/2.7	100mm	140mm
CLBR3.6/150/2.7	150mm	190mm
CLBR3.6/175/2.7	175mm	215mm
3.6mm outer wires with 2.5mm cross wires		
Length	2700mm +/- 1.5%	
Profile Height	4mm +/- 0.4mm	
Longitudinal Wire Size	3.6mm +/- 0.1mm	
Cross Wire Size	2.5mm +/- 0.1mm	
Pitch of Cross Wires	450mm +/- 3.0%	
Characteristics Yield Strength	500N/mm ²	
Lap Length	225mm	
Shear Load Capacity Wields	4306N	

CLBR5		
Product Ref.	Product Width	Wall Width
CLBR5/60/2.7	60mm	100mm
CLBR5/100/2.7	100mm	140mm
CLBR5/150/2.7	150mm	190mm
CLBR5/175/2.7	175mm	215mm
5mm outer wires with 2.5mm cross wires		
Length	2700mm +/- 1.5%	
Profile Height	3.5mm +/- 0.4mm	
Longitudinal Wire Size	5.0mm +/- 0.1mm	
Cross Wire Size	2.5mm +/- 0.1mm	
Pitch of Cross Wires	450mm +/- 3.0%	
Characteristics Yield Strength	500N/mm ²	
Lap Length	225mm	
Shear Load Capacity Wields	3172N	

Important note: Specifiers now use various wire diameters, if possible please check specification. Note: BS5628 part 2 recommends that Stainless Steel material should be used on an external wall, including the inner leaf of a cavity wall.

Frame Cramps & Movement Ties

Cramps

Ref: CFC

Frame Cramps are used for restraining masonry to new or existing masonry and to columns (steel or & concrete). Can also be used for restraining non-structural elements such as frames.

A Plain End Frame Cramp is also available for use with Debonding Sleeve (CDS supplied as extra) allowing lateral movement.

Supplied in boxes of:

Frame Cramps (CSEF) are supplied in Galvanised or Stainless Steel Grade 304 and supplied in Boxes of 250



CFC Movement Ties

Shear Load capacity	2060N
Minimum Embedment	62.5mm
Minimum Mortar Joint	10mm
Protection	150mm - 300mm
Lengths	150mm, 200mm, 225mm, 250mm, 300mm

Movement Ties

Ref: CPET

Movement ties are used over a movement joint in masonry providing restraint in one direction and movement in the other when used with a Debonding Sleeve (CDS supplied separately)

Supplied in boxes of:

Movement Ties (CPET) are supplied in Galvanised and Stainless Steel Grade 304 and supplied in boxes of 250



CPET Movement Ties

Shear Load capacity	1180N
Minimum Embedment	62.5mm
Minimum Mortar Joint	10mm
Protection	75mm - 300mm
Lengths	75mm, 100mm, 150mm, 175mm, 200mm, 225mm, 250mm, 300mm

Debonding Sleeves

Ref: CDS

Plastic Debonding Sleeves are suitable for use with Plain Ended Frame Cramps and Movement Ties.

Supplied in boxes of:

100mm 120mm 150mm & 200mm in bags of 250

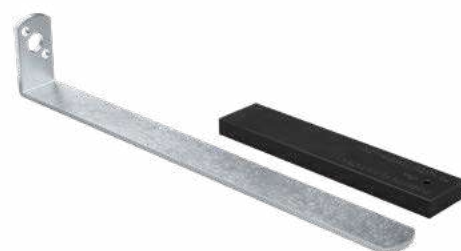

Expansion indicator sight hole allows setting of the steel insert

Technical Specification Clauses

1. Angle bead or corner bead

Galvanised Angle bead shall be manufactured in accordance with BS EN 103658: 2008 Parts 1 & 2 using galvanised steel to BS EN 10346: 2009-DX51D+Z275 with 45mm (53mm: 65mm) wing size as manufactured by Catnic under code reference SS3.0 (STD3.0: WW3.0).

Stainless Angle bead shall be manufactured in accordance with BS EN 103658: 2008 Parts 1 & 2 using stainless steel to BS EN 10088-2-1.4301 with 53mm wing size as manufactured by Catnic under code reference STD3.0SS.

2. Plasterstop or casing bead

Galvanised Plasterstops shall be manufactured in accordance with BS EN 103658: 2008 Parts 1 & 2 using galvanised steel to BS EN 10327-DX51D+Z275 and to suit plaster thickness of 10mm (13mm: 16mm: 19mm) as manufactured by Catnic under code reference PS10/3.0 (PS13/3.0:PS16/3.0: PS19/3.0).

Stainless Plasterstops shall be manufactured in accordance with BS EN 103658: 2008 Parts 1 & 2 using stainless steel to BS EN 10088-2-1.4301 and to suit plaster thickness of 10mm (13mm: 16mm: 19mm) as manufactured by Catnic under code reference PS10/3.0/SS (PS13/3.0/SS: PS16/3.0/SS: PS19/3.0/SS).

3. Architrave beads

Galvanised Architrave beads shall be manufactured in accordance with BS EN 103658: 2008 Parts 1 & 2 using galvanised steel to BS EN 10346: 2009-DX51D+Z275 and to suit plaster thickness of 10mm and 13mm without and with return flange as manufactured by Catnic under code reference ARC10/WF/3.0 (ARC13/WF/3.0: ARC20/WF/3.0) or ARC10WO/3.0 (ARC13/WO/3.0).

Stainless Architrave beads shall be manufactured in accordance with BS EN 103658: 2008 Parts 1 & 2 using stainless steel to BS EN 10088-2-1.4301 and to suit plaster thickness of 10mm and 13mm without and with return flange as manufactured by Catnic under code reference ARC10/WF/3.0/SS (ARC10/WF/3.0/SS, ARC13/WO/3.0/SS, ARC13/WF/3.0/SS, ARC20/WF/3.0/SS).

4. Movement bead

Galvanised Movement beads shall be manufactured in accordance with BS EN 103658: 2008 Parts 1 & 2 using galvanised steel to BS EN 10346: 2009-DX51D+Z275 and to suit plaster thickness of 12mm (15mm: 18mm: 21mm) as manufactured by Catnic under code reference MB10/3.0 (MB13/3.0: MB16/3.0: MB19/3.0).

Stainless Movement beads shall be manufactured in accordance with BS EN 103658: 2008 Parts 1 & 2 using stainless steel to BS EN 10088-2-1.4301 and to suit plaster thickness of 12mm (15mm: 18mm: 21mm) as manufactured by Catnic under code reference MB10/3.0/SS (MB13/3.0/SS: MB16/3.0/SS: MB19/3.0/SS).

5. Renderstop

Galvanised Renderstops shall be manufactured in accordance with BS EN 103658: 2008 Parts 1 & 2 using galvanised steel to BS EN 10346: 2009-DX51D+Z275 as manufactured by Catnic under code reference RS3.0.

Stainless Renderstops shall be manufactured in accordance with BS EN 103658: 2008 Parts 1 & 2 using stainless steel to BS EN 10088-2-1.4301 as manufactured by Catnic under code reference RS/3.0/SS.

6. Expanded metal lath

Galvanised Expanded metal lath shall be manufactured in accordance with BS EN 103658: 2008 Parts 1 & 2 using galvanised steel to BS EN 10346: 2009-DX51D+Z275 and weighing 0.90kgs per sq.metre (1.11kgs per sq.metre: 1.61kgs per sq.metre) as manufactured by Catnic under code reference DL089 (DL111: DL161).

Stainless Expanded metal lath shall be manufactured in accordance with BS EN 103658: 2008 Parts 1 & 2 using stainless steel to BS EN 10088-2-1.4301 and weighing 1.11kgs per sq.metre as manufactured by Catnic under code reference DL111S.

7. Rib Lath

Galvanised Rib Lath shall be manufactured in accordance with BS EN 103658: 2008 Parts 1 & 2 using galvanised steel to BS EN 10346: 2009-DX51D+Z275 with 10mm ribs at 100mm centres and weighing 1.48kgs per sq.metre (1.84kgs per sq.metre: 2.22 per sq.metre) as manufactured by Catnic under code reference RIB148 (RIB184: RIB222).

Stainless Rib Lath shall be manufactured in accordance with BS EN 103658: 2008 Parts 1 & 2 using stainless steel to BS EN 10088-2-1.4301 with 10mm ribs at 100mm centres and weighing 1.48kgs per sq.metre (1.84kgs per sq.metre) as manufactured by Catnic under code reference RIB148/SS (RIB184/SS).

8. Steel lintels

Steel lintels shall be manufactured in accordance with BS EN 845: 2013 using galvanised steel to BS EN 10346: 2009-DX51D+Z275 and coated with a thermosetting polyester powder coating as manufactured by Catnic.



Stay up to date
on the latest
Catnic News

catnic.com

catnic[®]

CATNIC WORLD

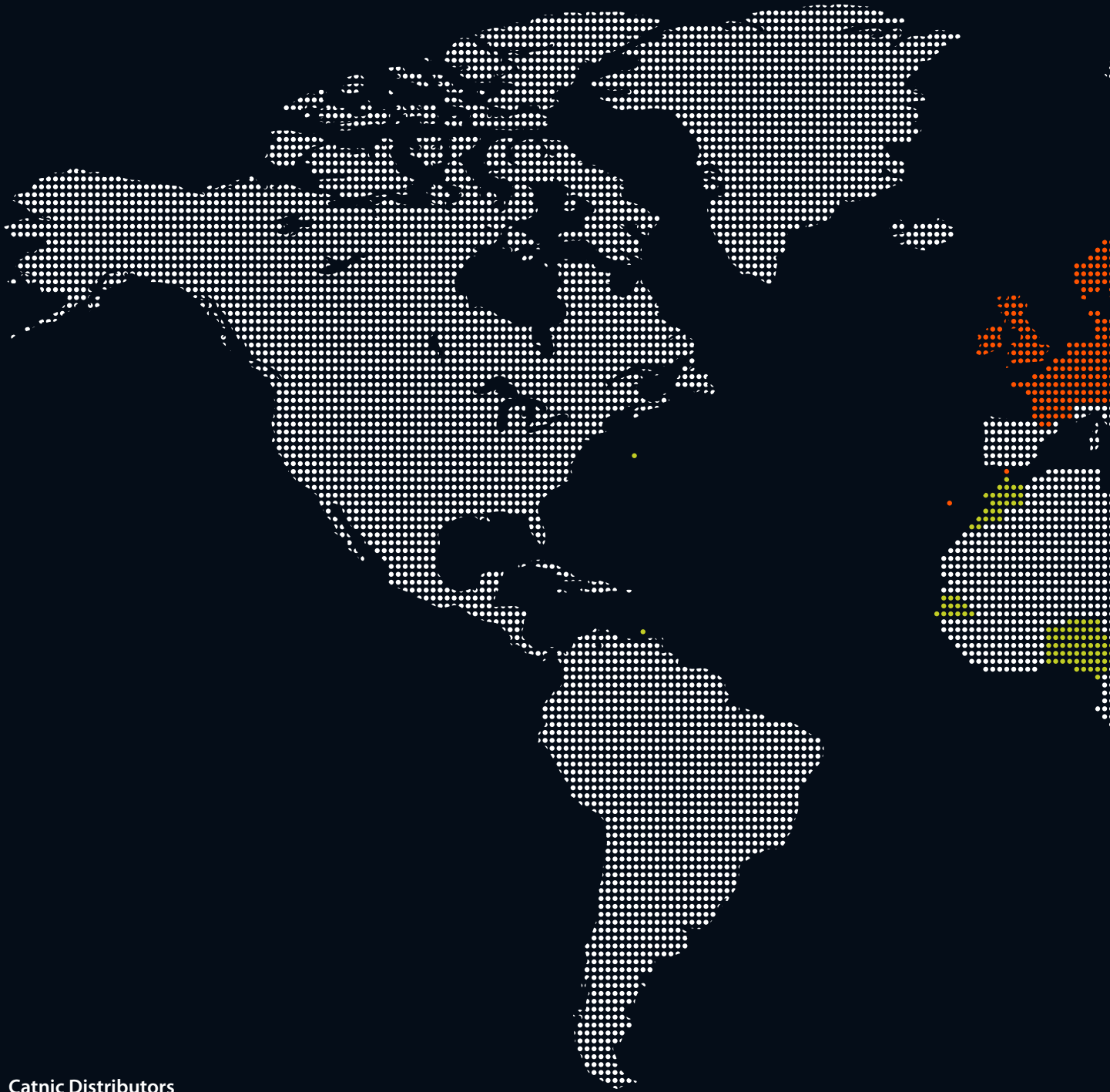

■ Catnic Distributors

Albania	Czech Republic	Hong Kong	Malta	Switzerland
Austria	Denmark	Hungary	Northern Ireland	Turkey
Bahrain	Egypt	Ireland	Norway	Uganda
Belgium	Estonia	Jordan	Oman	United Arab Emirates
Bosnia Herzegovina	France	Kuwait	Qatar	United Kingdom
Bulgaria	Germany	Latvia	Romania	
Canary Islands	Gibraltar	Lebanon	Saudi Arabia	
Croatia	Greece	Lithuania	Slovakia	
Cyprus	Holland	Macedonia	Sweden	

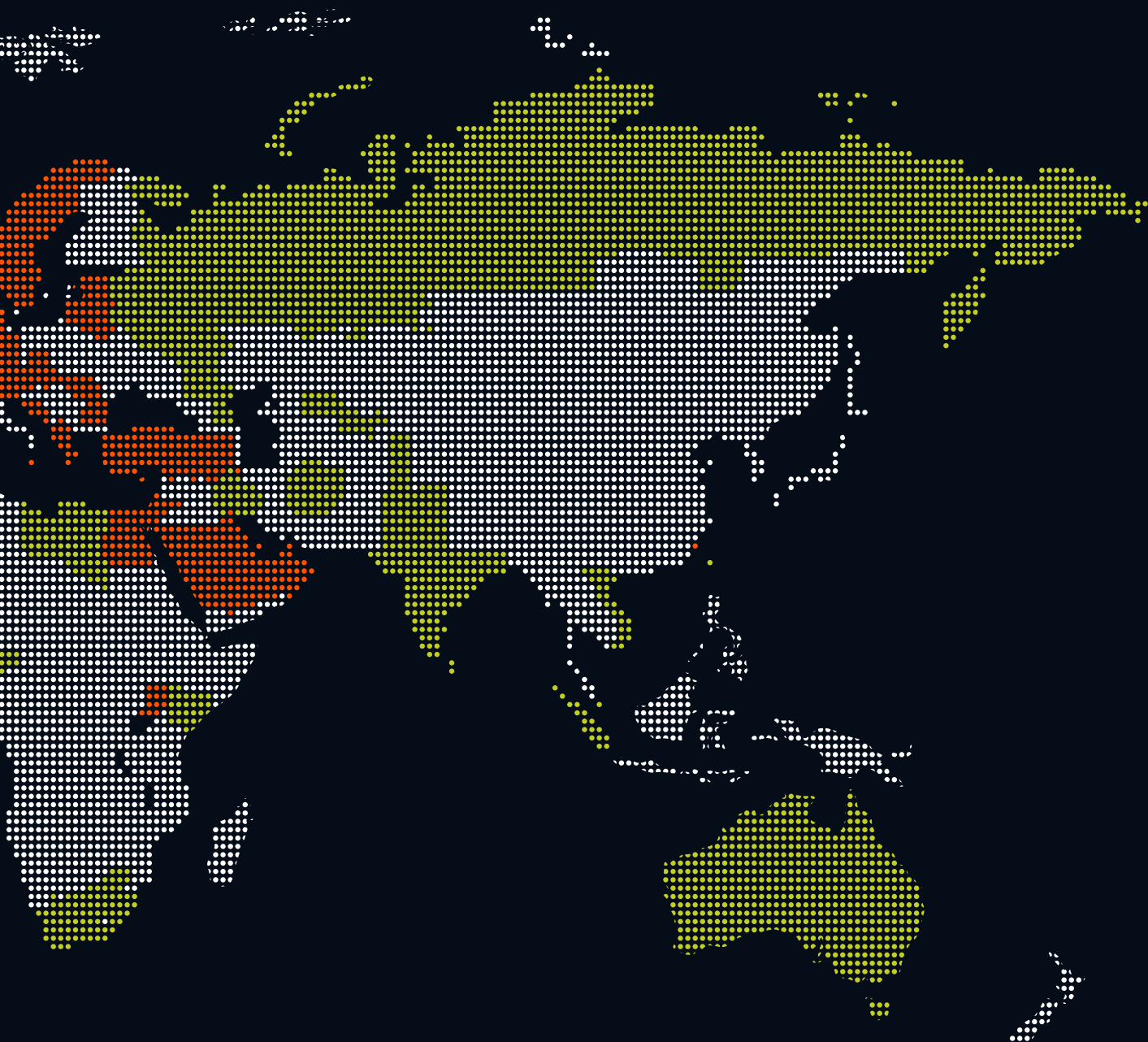

■ Catnic Products Used

- | | | |
|-------------|--------------|------------|
| Afghanistan | Libya | Taiwan |
| Australia | Morocco | Uzbekistan |
| Bermuda | Nigeria | Vietnam |
| Grenada | Russia | |
| India | Senegal | |
| Iraq | South Africa | |
| Kenya | Singapore | |

www.catnic.com

Catnic Conditions of Sale can be downloaded from
www.catnic.com

Care has been taken to ensure that the contents of this publication are accurate, but Tata Steel Europe Limited and its subsidiaries, which includes Tata Steel UK Limited, do not accept responsibility or liability for errors or information that is found to be misleading. Suggestions for, or descriptions of, the end use or application of products or methods of working are for information only and Tata Steel Europe Limited and its subsidiaries accept no liability in respect thereof.

Before using products or services supplied or manufactured by Tata Steel Europe Limited and its subsidiaries, customers should satisfy themselves as to their suitability.

Catnic reserves the right to change information contained within this brochure at any time.

© Copyright 2019 Tata Steel UK Limited

Catnic
Pontypandy Industrial Estate
Caerphilly
CF83 3GL
T: 029 2033 7900
F: 029 2086 7796
www.catnic.com

English version